

Design Guidelines for Shielding Effectiveness, Current Carrying Capability, and the Enhancement of Conductivity of Composite Materials

R.W. Evans

Tec-Masters, Inc. • Huntsville, Alabama

Prepared for Marshall Space Flight Center
under Contract NAS8-39983

and sponsored by
the Space Environments and Effects Program
managed at the Marshall Space Flight Center

National Aeronautics and Space Administration
Marshall Space Flight Center • MSFC, Alabama 35812

August 1997

PREFACE

These guidelines address the electrical properties of composite materials which may have an effect on electromagnetic compatibility (EMC). The main topics of the guidelines include the electrical shielding, fault current return, and lightning protection capabilities of composite materials. These guidelines concentrate on the composites that are somewhat conductive but may require enhancement to be adequate for EMC purposes. These composites primarily consist of graphite reinforced polymers.

An introduction to resistivity, conductivity, and intrinsic impedance of materials is included for informational purposes. This information is useful for determining characteristics of various types of composite materials and their shielding, current carrying, and lightning protection capabilities.

Methods for determining adequate conductivity levels for various EMC purposes are defined, and methods of increasing conductivity of composite materials and joints are described.

Funding for this study was provided by the Space Environments and Effects (SEE) Program administered by NASA MSFC's Electromagnetics and Aerospace Environments Branch through Contract NAS8-39983.

Mr. Steven Pearson was the technical monitor for this contract. He was assisted by Mr. Matthew McCollum. Mr. Tony Clark reviewed certain sections of the report and provided supporting theory. From Tec-Masters, Inc., Mr. Dennis Camp was the Senior Engineer, and Ms. Marla Luttrell proofread documents and provided publication advice. Mr. Ross Evans, Tec-Masters, Inc., was the Principal Investigator who performed the contracted effort of this program.

TABLE OF CONTENTS

	Page
Preface	iii
Acronyms and Abbreviations	viii
1.0 Introduction	1
2.0 Materials Description	3
2.1 Plastics	3
2.2 Graphite Fiber Reinforced Plastic	4
3.0 Summary of Conductivity Required	6
4.0 Impedance of Materials	9
4.1 Resistivity	9
4.2 Conductivity	12
4.3 Intrinsic Impedance of Materials	15
4.3.1 Intrinsic Impedance of Air	15
4.3.2 Intrinsic Impedance of Metals	16
4.3.3 Skin Depth	17
5.0 Shielding Effectiveness	19
5.1 Shielding Effectiveness Calculation and Comparison	19
5.1.1 Quick Estimate of Shielding Effectiveness	19
5.1.2 More Exact Calculations	20
5.2 General Equations for Shielding Effectiveness	23
5.2.1 Outline of Method for Calculating Shielding Effectiveness of Metal or Other Conductive Materials	27
5.3 Apertures	30
5.3.1 Shielding Effectiveness of a Conductive Panel With Apertures	31
5.3.2 Shielding Effectiveness of Panel With Subdivided Aperture	34
5.3.3 Shielding Effectiveness of Wire Screens or Conductive Meshes	35
5.4 Summary of Shielding Effectiveness Determination	36

6.0	Current Carrying Capability	39
6.1	Electrostatic Discharge (ESD) Protection	39
6.2	Radio Frequency (RF) and Shielding	40
6.3	Antenna Ground Plane	42
6.4	Fault Current	42
6.5	Lightning Protection	44
6.5.1	Environment	44
6.5.2	Specifications	45
6.5.3	Direct Effects	47
6.5.4	Indirect Effects	48
6.5.5	Protection	49
6.6	Galvanic Reaction	56
6.7	Summary of Protection Methods	57

TABLES

	Page
Table 1. Steps to Determine Resistivity and Conductivity of Composite Materials	13
Table 2. Typical Resistivity and Conductivity Values	14
Table 3. Additional Shielding Effectiveness Due to Shadow Effect	33
Table 4. Steps to Determine Total Shielding Effectiveness	37
Table 5. Damage from Direct Strikes	52
Table 6. Review of Protection Methods	58

FIGURES

	Page
Figure 1. Resistivity Definitions	9
Figure 2. Shielding Effectiveness, Frequency, Thickness, and Surface Resistance	21
Figure 3. Quick Estimate of Shielding Effectiveness	22
Figure 4. Path of a Radiated Wave Through a Barrier	23
Figure 5. Rereflection Coefficient B(dB)	26
Figure 6. Aperture Dimensions	31
Figure 7. Subdivided Apertures	34
Figure 8. Wire Screen	35
Figure 9. Examples of Shielding Effectiveness of Materials and Slots	38
Figure 10. Lightning Protection	55

REFERENCES

	Page
References	60

ACRONYMS AND ABBREVIATIONS

A	current (amps), or cross sectional area (m ²)
A _{dB}	absorption loss (dB)
B _{dB}	rereflection coefficient (dB)
°C	centigrade
cm	centimeters
d	depth of slot
dB	decibels
dc	direct current
D	box depth
e	2.718
E	electric field strength (V/m)
E _i	incident wave, electric field strength (V/m)
EMC	electromagnetic compatibility
EMI	electromagnetic interference
E _r	reflected wave, electric field strength (V/m)
ESD	electrostatic discharge
E _t	transmitted wave, electric field strength (V/m)
f	frequency (Hz)
f _{MHz}	frequency (MHz)
F	farads
g	air gap
GFRP	graphite fiber reinforced plastic
H	magnetic field strength (A/m), henries, or box height
Hz	hertz
j	$\sqrt{-1}$
k	a constant depending upon distance and source impedance
kA	kiloamps
K	a ratio of wave impedance to metal impedance
l	length (m or cm)
ln	natural logarithm
log	logarithm to the base 10

L	frame opening or slot length (m or mm)
L_A	slot length after subdivision
L_B	slot length before subdivision
m	meters
mm	millimeters
MEDIC	MSFC EMC Design and Interference Control (a handbook)
MHz	megahertz
MSFC	Marshall Space Flight Center
NASA	National Aeronautics and Space Administration
Ni	nickel
r	distance from source (m)
R_{dB}	reflection loss (dB)
RF	radio frequency
R_m	measured resistance (ohms)
R_s	surface resistance (ohms/square)
s	seconds
S	slot height or width (mm)
S_A	slot width after subdivision
S_B	slot width before subdivision
SE	shielding effectiveness
SE_{dB}	shielding effectiveness (dB)
SEE	Space Environments and Effects
SE_E	shielding effectiveness, electric field
SE_H	shielding effectiveness, magnetic field
SE_{shad}	shielding effectiveness due to shadow effect
SE_{total}	total shielding effectiveness
t	thickness (mils, m, or mm)
t_{cm}	thickness (cm)
t_m	thickness (m)
V	volts
w	width (m or cm)
W	box width
Z	impedance or intrinsic impedance (ohms)
Z_{air}	intrinsic impedance of air (ohms)
Z_B	intrinsic impedance of thin metal (ohms)

Z_m	intrinsic impedance of metal (ohms)
Z_s	source impedance (ohms)
Z_w	wave impedance
α	attenuation constant
δ	skin depth (cm or m)
ΔSE	change in SE due to subdividing slots
ϵ	permittivity (farads/m)
ϵ_0	permittivity of air or space (8.84×10^{-12} farads/m)
ϵ_r	permittivity relative to air
λ	wavelength (m)
μ	permeability (henries/m)
μ_0	permeability of air ($4\pi \times 10^{-7}$ henries/m)
μ_r	permeability relative to air
π	3.1416
ρ	volume resistivity (ohm meter or ohm cm)
ρ_{cu}	resistivity of copper (1.724×10^{-8} ohm meter)
ρ_r	resistivity relative to copper
σ	conductivity (mhos/m)
σ_{cu}	conductivity of copper (mhos/m)
σ_r	conductivity relative to copper
ω	$2\pi f$ - angular frequency

DESIGN GUIDELINES FOR SHIELDING EFFECTIVENESS, CURRENT CARRYING CAPABILITY, AND THE ENHANCEMENT OF CONDUCTIVITY OF COMPOSITE MATERIALS

1.0 INTRODUCTION

Electromagnetic compatibility (EMC) occurs when all equipment in a system operates properly without electronic interference from equipment within or outside the system. Electromagnetic interference (EMI) occurs when there is a source of emission, a unit that is susceptible, and a method of transmission between the two. Thus, electromagnetic interference can be controlled by reducing unnecessary emissions, reducing susceptibility, and/or interrupting the transmission path.

Electromagnetic compatibility requires electrically conductive structure and joints that provide an RF ground plane for filters, electrostatic discharge protection, electromagnetic shielding, fault current return, an antenna ground plane, and lightning protection. Highly conductive material of adequate thickness and sound electrical bonding connections at joints are the primary components of a conductive structure. General guidelines for control of EMI can be found in the MSFC Electromagnetic Compatibility Design and Interference Control (MEDIC) Handbook, NASA Reference Publication 1368. [1]

Equipment cases and the basic structure of spacecraft and launch vehicles have traditionally been made of aluminum, steel, or other electrically conductive metal. When proper attention is given to electrical bonding between segments and from equipment cases to structure, these highly conductive materials provide a good fault current return path, an RF ground plane for filters, and some degree of shielding against radiated emissions. However, in recent years composite materials have been used for spacecraft structure and equipment cases because of their lighter weight,

high strength, and ease of fabrication. Despite these benefits, composite materials are not as electrically conductive as traditional metal structures. Therefore, extra steps must be taken to alleviate this shortcoming. This document is partly tutorial, but it provides specific guidelines in the form of lists and charts to help meet EMC requirements while using composite materials in spacecraft.

2.0 MATERIALS DESCRIPTION

2.1 Plastics

Plastics are synthetic materials made from raw materials called monomers. Long chains of repeating monomers are called polymers. Thermoplastic polymers consist of long, intertwined chains with no physical connections between them. They typically can be melted and recast maintaining the characteristics of the original material.

Thermoset polymers consist of chains that are crosslinked together. Rigid thermosets have short chains with many crosslinks. Flexible thermosets have longer chains with fewer crosslinks. Thermoset polymers typically are formed by mixing a resin with a hardener and allowing the mixture to set under pressure until hard. Heat is usually applied to speed hardening. Thermoset polymers can not be melted and reformed into the original polymer. Due to the tightly crosslinked structure, thermoset plastics resist higher temperatures and provide greater dimensional stability than thermoplastics.

Composite materials have been developed to rectify some of the shortcomings of plastic compounds. A composite is any combination of two or more materials designed to achieve some characteristic not offered by any of the materials alone. This combination usually provides reinforcement for strength, but it may increase stability or electrical conductivity. Reinforcing material consists of long fibers or mats that tend to strengthen and stabilize the plastic. They may be added to either thermoplastic or thermoset polymers to provide greater strength and stability.

To fulfill mechanical property requirements for aerospace applications, various high strength fibers are combined with appropriate binding resins such as epoxy, polyester, or phenolic. Among the high strength fibers most used are graphite, boron,

Kevlar, and glass. Of these, only graphite offers some degree of electrical conductivity. Fortunately, graphite mats and long fibers are the reinforcement of choice for aerospace work.

Other methods may be used to increase conductivity, such as adding conductive fillers to the resin. Conductive fillers are usually small particles with low aspect ratios (small length to width) which are too small to provide reinforcement, and they could reduce the strength of the plastic alone. Typical conductive fillers include graphite flakes or fibers, metal coated graphite fibers, and metal flakes or fibers.

Conductivity may also be introduced by adding conductive screen, plating, or paint to the finished product. Increasing the conductivity of finished composite panels or cabinets by adding a conductive coating is a common practice in the commercial electronic cabinet industry. The technologies used to form conductive coatings include flame spray, arc spray, vacuum metallization, conductive paints, electroless plating, ion plating, conductive foil or tape, conductive filled plastic, and inherently conductive plastic. All of these methods provide some degree of shielding when used on enclosures. Compliance with FCC rules may only require 30 to 40 dB of electromagnetic shielding.

New plastics and new methods of reinforcement are constantly being developed and introduced, but the composite most often chosen for aerospace use is some form of graphite fiber reinforced plastic (GFRP).

2.2 Graphite Fiber Reinforced Plastic

Shielding and current-carrying capabilities are directly related to conductivity. Where these capabilities are desired, resin with nonconductive reinforcement is clearly unacceptable for use as spacecraft structure or equipment enclosures. The conductivity of metal structure and equipment cases has proved to be fully adequate when proper thickness and good conductive joints are used. The conductivity of GFRP is much less than the conductivity of metal sheets or metal fillers. However, the

conductivity of GFRP is much higher than plastic alone or plastic with nonconductive reinforcement, such as fiberglass.

Some form of graphite embedded in plastic is the most common composite material presently in use by the aerospace industry. One type of graphite composite is made from loose fibers that are mixed with resin and a hardening agent to form a solid composite. Another type is made from unidirectional fibers prepackaged with resin as tape or woven fabric. The tape or fabric is placed in layers, and pressure and heat are applied. This hardens the layers to form the finished composite material. The graphite is oriented to take advantage of the high strength of the fibers in the linear direction. The electrical conductivity is also greater in the direction the fibers are oriented. However, electrical conductivity can be fairly uniform if several layers of graphite are laid in various orientations.

The conductivity of most metals is 1000 times greater than that of graphite composites. The suitability of graphite composite material as conductive structure depends upon the extent of shielding or current carrying capability required and the amount and orientation of graphite fibers. If electrical bonding of the graphite composite mating surfaces can provide good conductivity across the joints, the total conductivity of a finished structure may be adequate for many applications. If additional conductivity is required for a specific application, conductive material may be added to the surface of the finished product or a layer of metallic material may be added as part of the laminate itself.

3.0 SUMMARY OF CONDUCTIVITY REQUIRED

Later sections of this document will show that for EMC related purposes the most important consideration for structural or equipment enclosure material is its electrical conductivity. We have noted that most metals provide adequate conductivity for EMC purposes, and highly resistive materials such as fiberglass epoxy composites cannot be used where shielding or current carrying capability is required. The resistivity of composites such as graphite fiber reinforced plastic (GFRP) may be 1000 times greater than that of most metals, but it is still much better than the highly resistive material. It is these "in-between" composites that are the subject of most of this document. The values of conductivity required varies with the purpose and the application, but the following summary presents general guidelines for conductivity required depending upon the purpose.

Electrostatic discharge -- Material with surface resistivity less than 1×10^7 ohm/square does not retain static charge when electrically bonded to conductive structure. Materials that have resistivity values above 1×10^{13} ohm/square can develop a static charge that will not dissipate even when bonded. Graphite reinforced material is generally conductive enough to prevent static charge development if the graphite particles protrude through the plastic to the surface. A surface coating of epoxy may be nonconductive enough to retain a charge, and an additional conductive coating may be required in some cases.

Electromagnetic Shielding -- A thin sheet of material with surface resistivity of 0.1 ohm/square will provide over 50 dB of shielding at frequencies above 1 MHz. Typical GFRP has a surface resistivity of 2×10^{-2} ohms/square, but may vary with graphite content. Resistivity of other materials with conductive filler or

coating may be considerably different. Thicker material adds some shielding especially at lower frequencies. Joints and apertures will degrade shielding effectiveness (SE) of the material, and they are usually the limiting factor in SE. Calculations should be made for the specific case using methods outlined in table 4 of section 5.

Antenna Ground Plane -- Surface resistivity less than one ohm/square is adequate for most antenna ground planes. GFRP usually meets this requirement. Discontinuities should be bridged with conductive tape or metal to present a relatively homogeneous, conductive surface.

Fault Current Return -- Mil-B-5087 requires joint resistance of metallic structure not to exceed 0.1 ohm for fault current paths. Since the resistance of graphite fiber material itself usually exceeds this value, the end to end resistance of the short circuit return path may be too high to conduct enough current to activate typical circuit protection devices. No matter how low the resistance of the path, tests have shown that short circuit current exceeding 5 amps usually causes fire at the shorting point to GFRP material. As noted in section 6.4, care must be taken to avoid the possibility of short circuits to GFRP. Ground fault circuit interrupters may be used in some cases where a fault current path through GFRP is unavoidable.

Lightning -- Good conductivity alone may not be enough to prevent damage from a direct strike. Thickness of the material is also important. Use a sacrificial layer of metal foil or screen as the top layer in composite material to help disperse current and heat. Use another one on the bottom if electric fields may be a problem to equipment inside the enclosure. Joints between composite panels must have good contact between top layers of foil or screen to carry the high current, and the bottom layers of conductive material used as an electric field shield must be

continuous without large gaps. Further information on lightning protection can be found in section 6.5.

Galvanic reaction -- Graphite is low in the galvanic series, below copper, and can be expected to cause corrosion to aluminum or other metal higher in the series. GFRP joined to aluminum should have an intermediate metal coating to reduce corrosion.

4.0 IMPEDANCE OF MATERIALS

4.1 Resistivity

The following short review of resistivity of materials defines the applicable terminology and provides equations to facilitate calculation.

Volume resistivity (ρ) is the resistance from one face of a unit sized cube of material to the opposite face. When the cube is one cubic meter, volume resistivity is stated in ohm-meters. The volume resistivity in ohm-meters may be converted to ohm-cm by multiplying by 100.

Surface resistivity (R_s), in ohms/square, is the resistance from one edge of a square of thin material to the opposite edge. Any size square has the same value for a given thickness.

Figure 1 depicts resistivity definitions pictorially.

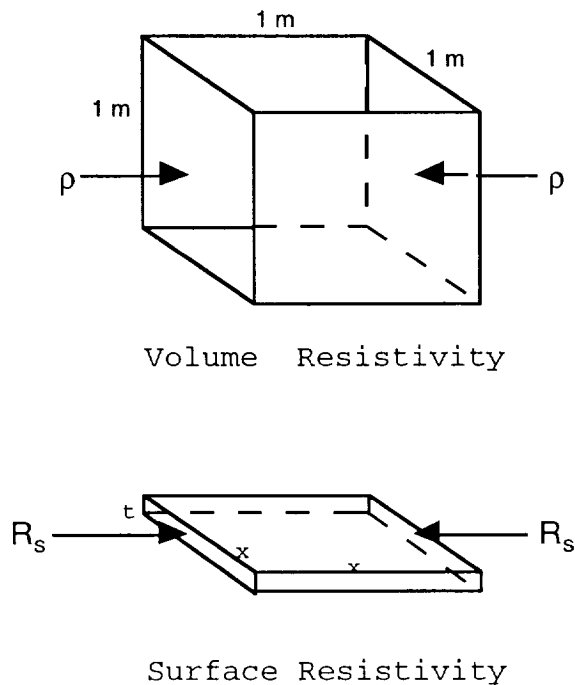

Figure 1. - Resistivity Definitions

If volume resistivity of a homogeneous material is known, surface resistivity can be found by dividing the volume resistivity by the thickness of the surface:

$$R_s = \frac{\rho}{t} \quad (1)$$

Where,

R_s = surface resistivity in ohms/square

ρ = volume resistivity in ohm-meters

t = thickness of the conductive surface in meters

If volume resistivity is in ohm-cm, use thickness in cm to determine surface resistivity in ohms/square.

Notice that volume resistivity remains constant for a given material. Surface resistivity varies inversely with thickness.

The relative resistivity of a material is the volume resistivity of the material divided by the resistivity of copper:

$$\rho_r = \frac{\rho}{\rho_{cu}} \quad (2)$$

Where,

ρ_r = resistivity of a material relative to copper

ρ = volume resistivity of a material, ohm-meters

ρ_{cu} = volume resistivity of copper, ohm-meters

$\rho_{cu} = 1.724 \times 10^{-8}$ ohm-meters

In practice, the surface of a composite material may consist of nonconductive plastic, and true surface resistivity may be very high. These definitions assume a homogeneous material and uniform distribution of current throughout the material. Practical measurement requires very low relative resistance from the measuring probes to the whole face of the cube for volume resistivity measurement and to the whole edge of the sheet for surface resistivity measurement. One reasonably accurate method of measurement for composite material uses a small block sample. The ends are lightly sanded to expose conductive fibers. The sanded ends are then coated with conductive paint to provide a consistent contact and a surface with much better conductivity

than the composite material being measured. Resistance is then measured end to end between the conductive surfaces of the block sample.

Surface resistivity is the measured resistance (R_m) times the width, divided by the length in meters to give ohms per square. Volume resistivity in ohm-meters is attained by multiplying the surface resistivity by the thickness in meters.

$$R_s = R_m \left(\frac{w}{l} \right) \quad (3)$$

$$\rho = R_m \left(\frac{w}{l} \right) (t)$$

$$\rho = R_s (t) \quad (4)$$

Where,

R_s = surface resistivity (ohms per square)

R_m = measured resistance (ohms)

w = width (m)

l = length (m)

t = thickness (m)

ρ = volume resistivity (ohm meters)

The resistance is lower in the linear direction of the graphite fiber in single layer mats and tapes. However, several layers of material are usually oriented at different angles to provide strength for the finished graphite fiber reinforced plastic (GFRP). When four or more layers with different orientations are used, resistance calculations can be made on the finished composite as if it is a homogeneous material. The volume resistivity of the material may be determined as described above.

Tests have shown that the ac resistance of GFRP is close to the value for dc resistance at low frequencies. At higher frequencies the inductive reactance, which is more shape dependent than material dependent, exceeds the dc resistance just as it does in a metallic conductor. [2]

4.2 Conductivity.

Conductivity (σ) is the reciprocal of volume resistivity.

$$\sigma = \frac{1}{\rho} \text{ Siemens/meter or mhos/meter} \quad (5)$$

The relative conductivity (σ_r) of a material is the conductivity of the material divided by the conductivity of copper:

$$\sigma_r = \frac{\sigma}{\sigma_{cu}} \quad (6)$$

Where,

σ_r = relative conductivity of a material

σ = conductivity of the material, mhos/meter

σ_{cu} = conductivity of copper, mhos/meter

$\sigma_{cu} = 5.8 \times 10^7$ mhos/meter

Relative resistivity (ρ_r) and conductivity (σ_r) are used extensively in impedance and shielding effectiveness calculations.

Table 1 lists specific steps for measuring resistance and determining resistivity and conductivity of rectangular samples of composite material.

Some typical resistivity values are given in table 2 to show relationship between the resistivity of various materials and to provide values for rough calculations.

Table 1. - Steps to Determine Resistivity and Conductivity of Composite Materials

- Expose conductive fibers by sanding opposite ends of a rectangular sample.
 - Make good electrical contact with the fibers by applying conductive paint to the sanded ends.
 - Measure resistance (R_m) from end to end.
 - Surface resistivity (R_s) = $R_m \left(\frac{w}{l} \right)$ ohms/square.
 - Volume resistivity (ρ) = $R_s(t)$ ohm-meters.
 - Conductivity (σ) = $\frac{1}{\rho}$ mhos/meter.
 - Relative conductivity $\sigma_r = \frac{\sigma}{\sigma_{cu}}$
- or,
- $\sigma_r = \frac{1.724 \times 10^{-6}}{R_s \times t_{cm}}$

Where,

$$\sigma_{cu} = 5.8 \times 10^7 \text{ mhos/meter}$$

w = width of sample (meters)

l = length of sample (meters)

t = thickness of sample (meters)

t_{cm} = thickness (centimeters)

Table 2. - Typical Resistivity and Conductivity Values

MATERIAL	THICKNESS		RESISTIVITY				CONDUCTIVITY			
	mil	cm	ohm-meter	Volume		Surface		mho/meter	mho/cm	relative
				ohm-centimeter	ohm/square	ohm/square				
Copper		0.100	1.72E-08	1.72E-06	1.72E-03	5.81E+07	5.81E+05	1.00E+00		
Aluminum		0.100	2.87E-08	2.87E-06	2.87E-03	3.48E+07	3.48E+05	6.01E-01		
Cold rolled steel		0.100	1.01E-07	1.01E-05	1.01E-02	9.90E+06	9.90E+04	1.71E-01		
Stainless steel		0.100	8.62E-07	8.62E-05	8.62E-02	1.16E+06	1.16E+04	2.00E-02		
Steel filaments in plastic		0.100	2.00E-03	2.00E-01	2.00E+02	5.00E+02	5.00E+00	8.62E-06		
10% stainless filaments		0.320	8.20E-03	8.20E-01	2.56E+00	1.22E+02	1.22E+00	2.10E-06		
Zinc plating	1	0.003	5.70E-08	5.70E-06	1.90E-03	1.75E+07	1.75E+05	3.02E-01		
GFRP (typ.)		0.100	1.80E-05	1.80E-03	1.80E+00	5.56E+04	5.56E+02	9.58E-04		
GFRP (meas.)		0.360	8.64E-05	8.64E-03	2.40E-02	1.16E+04	1.16E+02	2.00E-04		
40% Carbon fiber	70	0.178	1.00E+00	1.00E+02	5.62E+02	1.00E+00	1.00E-02	1.72E-08		
5% Ni coated graphite in polycarbonate	125	0.318	3.40E+02	3.40E+04	1.07E+05	2.94E-03	2.94E-05	5.07E-11		
10% "	125	0.318	5.20E-01	5.20E+01	1.64E+02	1.92E+00	1.92E-02	3.32E-08		
15% "	125	0.318	1.60E-03	1.60E-01	5.04E-01	6.25E+02	6.25E+00	1.08E-05		
20% "	125	0.318	1.10E-03	1.10E-01	3.46E-01	9.09E+02	9.09E+00	1.57E-05		

4.3 Intrinsic Impedance of Materials

All materials have an intrinsic impedance dependent upon the conductivity, permeability, and permittivity of the material. As an electromagnetic wave propagates through the material, the impedance of the wave approaches the intrinsic impedance of the material.

The general equation for intrinsic impedance is: [3]

$$Z = \sqrt{\frac{j\omega\mu}{\sigma + j\omega\epsilon}} \quad (7)$$

Where,

$$j = \sqrt{-1}$$

$$\omega = 2\pi f \quad \text{radians}$$

$$f = \text{frequency in Hz}$$

$$\mu = \text{permeability of the material} = (\mu_o\mu_r)$$

$$\mu_o = \text{permeability of air or space} = 4\pi \times 10^{-7} \text{ H/m}$$

$$\mu_r = \text{permeability of material relative to air}$$

$$\sigma = \text{conductivity of material} = (\sigma_{cu}\sigma_r)$$

$$\sigma_{cu} = \text{conductivity of copper} = 5.8 \times 10^7 \text{ mhos/meter}$$

$$\sigma_r = \text{conductivity of material relative to copper}$$

$$\epsilon = \text{permittivity of material} = (\epsilon_o\epsilon_r)$$

$$\epsilon_o = \text{permittivity of air or space} = 8.84 \times 10^{-12} \text{ F/m}$$

$$\epsilon_r = \text{permittivity of material relative to air}$$

4.3.1 Intrinsic Impedance of Air

In determining the intrinsic impedance of air, even though $j\omega\epsilon$ is small, the conductivity, σ , is much smaller -- i.e., approaches zero. Thus, for the impedance of air, equation 7 becomes:

$$Z_{\text{air}} = \sqrt{\frac{\mu}{\epsilon}} = 377 \text{ ohms} \quad (8)$$

An electromagnetic wave propagating through air at a distance (r) from the source, where $r \geq \frac{\lambda}{2\pi}$, the far field, has an impedance equal to Z_{air} .

In the near field, where $r \leq \frac{\lambda}{2\pi}$, the wave impedance depends upon the source impedance and the distance from the source. Assuming the source is small compared to a wavelength (λ), the wave impedance becomes:

$$Z_w = \frac{E}{H} = k377 \text{ ohms} \quad (9)$$

Where,

E = electric field strength (V/m)

H = magnetic field strength (A/m)

$k = 1$, if $r \geq \frac{\lambda}{2\pi}$

$k = \frac{\lambda}{2\pi r}$, if the source is high impedance and $r \leq \frac{\lambda}{2\pi}$

But Z_w cannot exceed the source impedance.

$k = \frac{2\pi r}{\lambda}$, if the source is low impedance and $r \leq \frac{\lambda}{2\pi}$

But Z_w cannot be less than the source impedance.

4.3.2 Intrinsic Impedance of Metals

In determining the intrinsic impedance of a metal, the conductivity is high and $\sigma \gg \omega\epsilon$. Assuming the thickness of the metal is greater than three times the skin depth ($t \gg 3\delta$), the intrinsic impedance (Z_m) of equation 7 becomes:

$$Z_m = \sqrt{\frac{j\omega\mu}{\sigma}} \text{ ohms/square} \quad (10)$$

or, in terms relative to copper:

$$Z_m = 369 \sqrt{\frac{\mu_r f_{\text{MHz}}}{\sigma_r}} \text{ micro-ohms per square} \quad (10a)$$

Z_m can also be expressed in terms of skin depth (δ) for any metal:

$$Z_m = \frac{\sqrt{2}}{\sigma\delta} \text{ ohms/square} \quad (10b)$$

Where,

$$\delta = \frac{1}{\sqrt{\sigma\pi f\mu}} \text{ meters}$$

4.3.3 Skin Depth

The skin depth is the depth within a metal where a current's amplitude at any frequency has decayed to $1/e$ (37%) of the current at the surface. At two skin depths, current has decayed to $1/e^2$ (14%), etc. So, 63% ($1-1/e$) of the current flows through metal between the surface and one skin depth; 86% ($1-1/e^2$) between the surface and two skin depths; etc., up to 99% at five skin depths. If the thickness of the metal is less than this, its apparent impedance is higher than that calculated for Z_m . For thin metal the intrinsic impedance (Z_B) becomes: [4]

$$Z_B = \frac{Z_m}{1 - \frac{1}{e^{\left(\frac{t}{\delta}\right)}}} \text{ ohms/square for any value of } t/\delta \quad (11)$$

For $t/\delta \ll 1$:

$$Z_B = \frac{\delta Z_m}{t} = \frac{\delta}{t} \times \frac{\sqrt{2}}{\sigma\delta} = \frac{\sqrt{2}}{t\sigma} \text{ ohms/square} \quad (11a)$$

or:

$$Z_B = \frac{2.438 \times 10^{-6}}{\sigma_r t_{cm}} \text{ ohms/square} \quad (11b)$$

The ratio (K) of wave impedance to metal impedance is used to determine reflection components in the shielding effectiveness equations in the next section.

$$K = \frac{Z_w}{Z_m} \quad \text{for } t > 3\delta \quad (12)$$

and:

$$K = \frac{Z_w}{Z_B} \quad \text{for } t < 3\delta \quad (12a)$$

5.0 SHIELDING EFFECTIVENESS

5.1 Shielding Effectiveness Calculation and Comparison

The shielding effectiveness (SE) of equipment cases and spacecraft skin is determined by the type of material used and the holes in that material. Typical metals, thick enough to provide adequate mechanical strength when used for equipment cases and spacecraft skin, provide acceptable SE. Holes and slots in the metal are the most common detriment to SE. Therefore, most shielding design effort concentrates on reducing the number and size of openings.

With the increased use of composite materials and nonconductive plastics, designers are concerned with the SE of the material as well as SE degradation caused by the holes and slots. Designers must rely on embedded conductive filaments, conductive paints, metal deposits, etc., in the composite material to make it conductive enough to provide adequate shielding where required.

5.1.1 Quick Estimate of Shielding Effectiveness

Figure 2 is a plot of SE versus frequency calculated for two values of surface resistivity. The plot also includes three different thicknesses for each value of surface resistivity. The plot shows a small variation in SE between 1 mm and 1 cm thick materials with the same surface resistance. However, across the frequency range and SE of interest, SE decreases approximately 30 dB with a tenfold increase in surface resistivity. Similar comparisons using other variables indicates that surface resistivity of a particular material can be used to determine the approximate SE across the limited resistivity and SE range of interest.

Figure 3 shows the same SE versus frequency for several values of surface resistivity for 1 mm thick material. Figure 3

may be used for quick SE estimates for composite materials with a resistivity in the range of interest. For example, materials with resistivity greater than 10 ohms/square obviously cannot be relied upon for shielding. However, materials with surface resistivity less than 0.001 ohms/square can provide SE approaching that of metal when apertures are considered.

Shielding effectiveness calculations are made using various assumptions and, sometimes, different equations that produce variations in the answers. When tests are made on sample materials, the test results vary with the test set up, test technique, and the operators. These differences are not usually enough to invalidate the results, but they are enough to show that shielding calculations and tests are not an exact science. This fact, and the fact that apertures and joints will be the driving factor in most final results if the material is very conductive, makes the use of a quick estimate of the material SE very attractive.

5.1.2 More Exact Calculations

In some cases the amount of shielding required of the material may be critical. In these specific cases determine a more exact SE. First, determine the proper thickness or conductivity for the material to provide adequate shielding. Then minimize the size of apertures in the material and provide good conductivity across all joints and covers.

More detailed calculations of material SE may be made using the equations in the next section. The "Outline of Method for Calculating SE of Conductive Material" provides an organized approach to these calculations and considers magnetic as well as electric fields.

The section on apertures must be used for SE calculation whether the "Equations for SE of Materials" or the "Quick Estimate" is used.

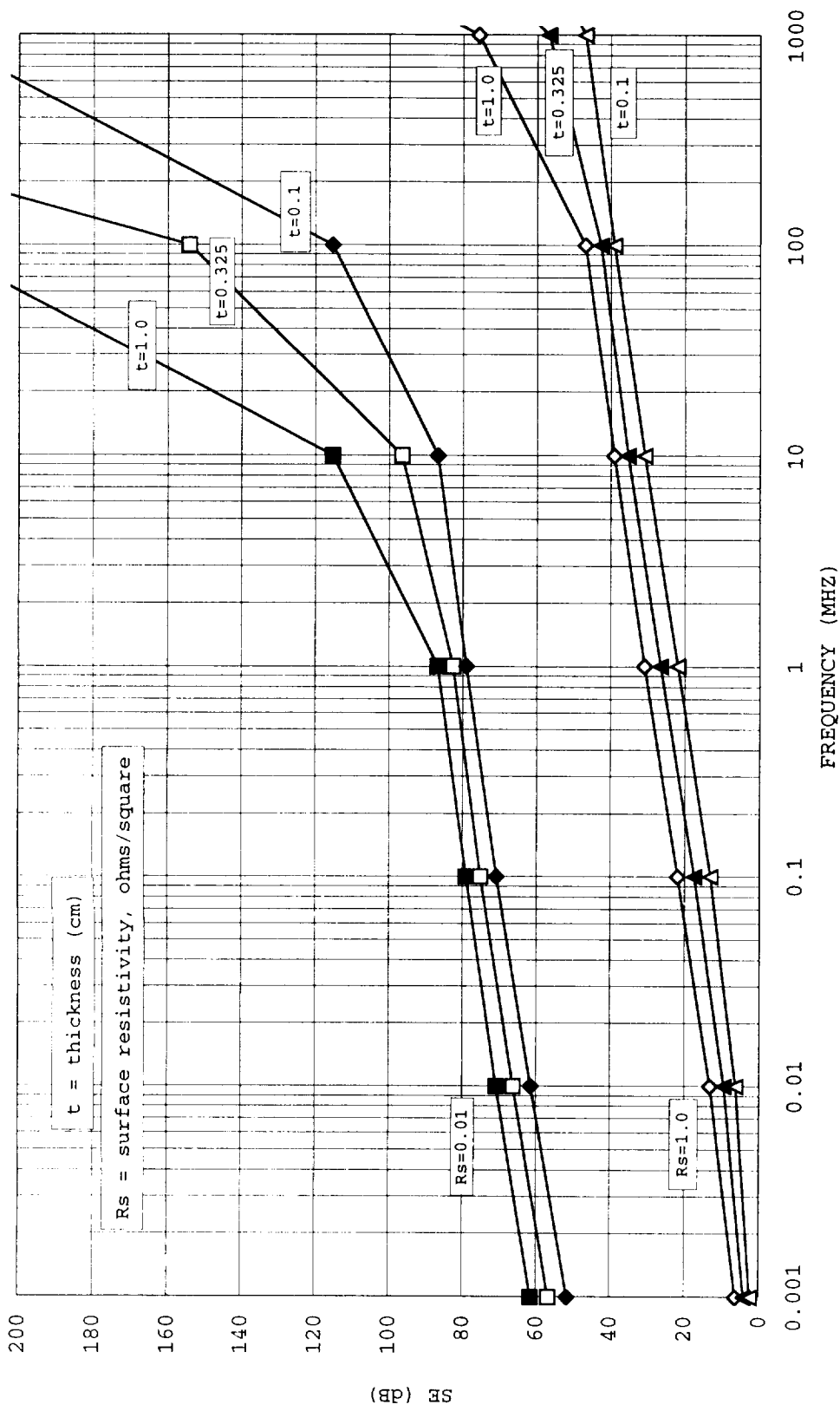

Figure 2. - Shielding Effectiveness Versus Frequency, Thickness, and Surface Resistivity

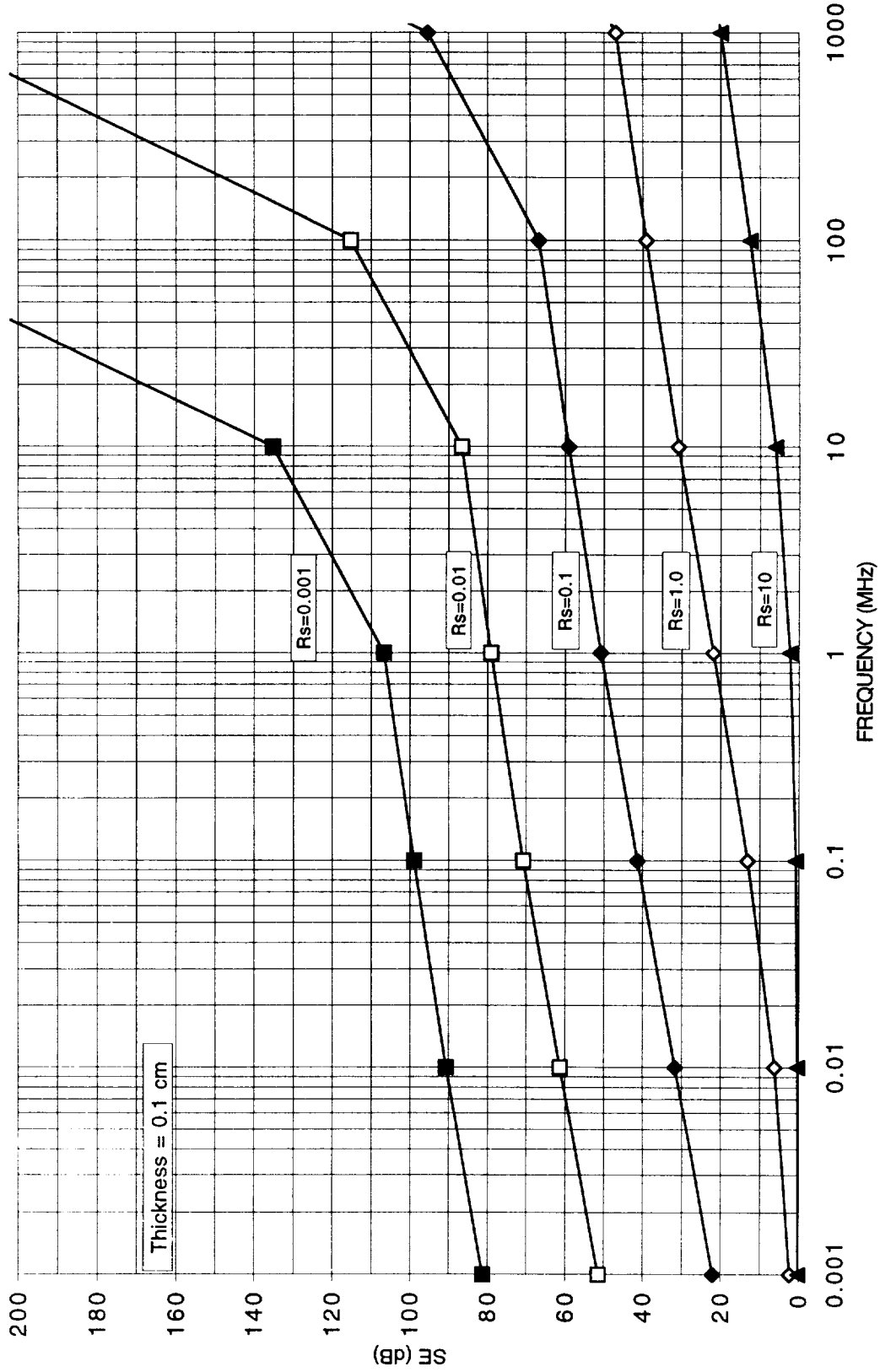

Figure 3. - Quick Estimate of Shielding Effectiveness

5.2 General Equations for Shielding Effectiveness

Shielding effectiveness of a barrier is defined as the ratio of radiated power received without the barrier in place to the power received with the barrier in place. It is usually stated in dB.

The SE of the barrier is caused by reflection from the surface due to the impedance mismatch between the two mediums and attenuation by absorption loss within the barrier. Rereflection, as shown in figure 4, occurs at the second barrier-to-air surface and again at the first surface. Some absorption loss occurs each time the wave traverses the thickness of the barrier. The rereflected component usually reduces SE by adding power to the output. The reduction may be significant if the absorption losses are low.

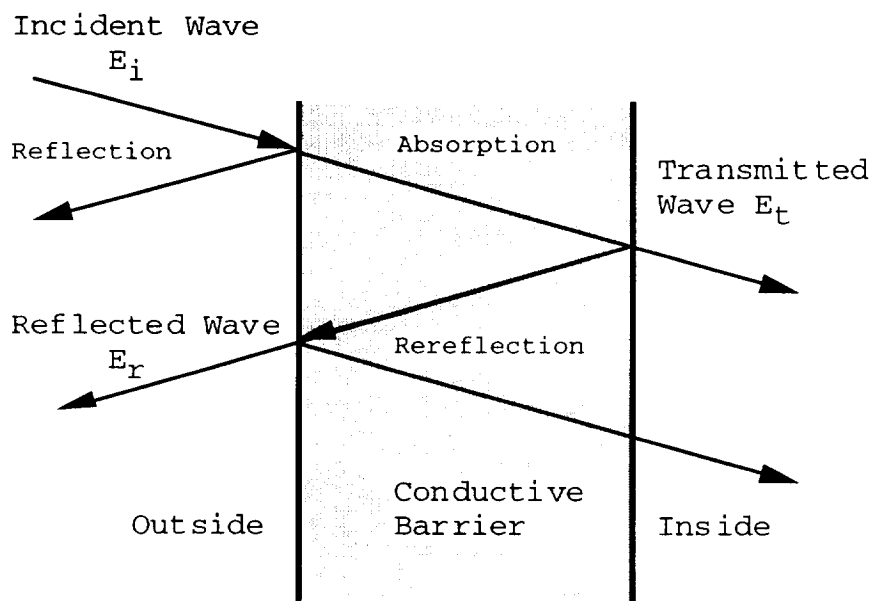

Figure 4. - Path of a Radiated Wave Through a Barrier

The equation for SE of a conductive sheet or panel takes the form:

$$SE = A_{dB} + R_{dB} + B_{dB} \quad (13)$$

Where,

A_{dB} = Attenuation due to absorption

R_{dB} = Loss due to reflection

B_{dB} = Rereflection correction

The separate terms can be found by the following: [3 & 4]

Absorption:

$$A_{dB} = 20 \log e^{\alpha t_m} = 8.686 \alpha t_m = 8.686 t_m \sqrt{\pi f \mu \sigma} \quad (14)$$

$$A_{dB} = 1314 t_{cm} \sqrt{f_{MHz} \mu_r \sigma_r} \quad (14a)$$

Where,

t = thickness of sheet or panel (m or cm)

Reflection:

$$R_{dB} = 20 \log \frac{(1 + K)^2}{4K} = 20 \log \frac{K}{4}, \text{ for } K \gg 1 \quad (15)$$

Where K is found in equations 12 or 12a.

In the far field, $\left(r \geq \frac{\lambda}{2\pi} \right)$,

for plane waves:

$$R_{dB} = 108.1 - 10 \log \left(\frac{\mu_r f_{MHz}}{\sigma_r} \right) \quad (15a)$$

In the near field, $\left(r \leq \frac{\lambda}{2\pi} \right)$,

for high impedance E fields:

$$R_{dB} = 141.7 - 10 \log \left(\frac{\mu_r f_{MHz}^3 r_m^2}{\sigma_r} \right) \quad (15b)$$

for low impedance H fields:

$$R_{dB} = 74.6 - 10 \log \left(\frac{\mu_r}{f_{\text{MHz}} \sigma_r r_m^2} \right) \quad (15c)$$

Rereflection:

$$B_{dB} = 20 \log \left[1 - \left(\frac{K - 1}{K + 1} \right)^2 \times 10^{-0.1 A_{dB}} (\cos 0.23 A_{dB} - j \sin 0.23 A_{dB}) \right] \quad (16)$$

$$B_{dB} = 20 \log \left(1 - e^{-2t\sqrt{\pi f \mu \sigma}} e^{-j2t\sqrt{\pi f \mu \sigma}} \right) \quad (16a)$$

See figure 5 for approximate values of B_{dB} , knowing A_{dB} and K .
 B_{dB} is a negative number that reduces total SE.
 B_{dB} can be ignored unless A_{dB} is small.

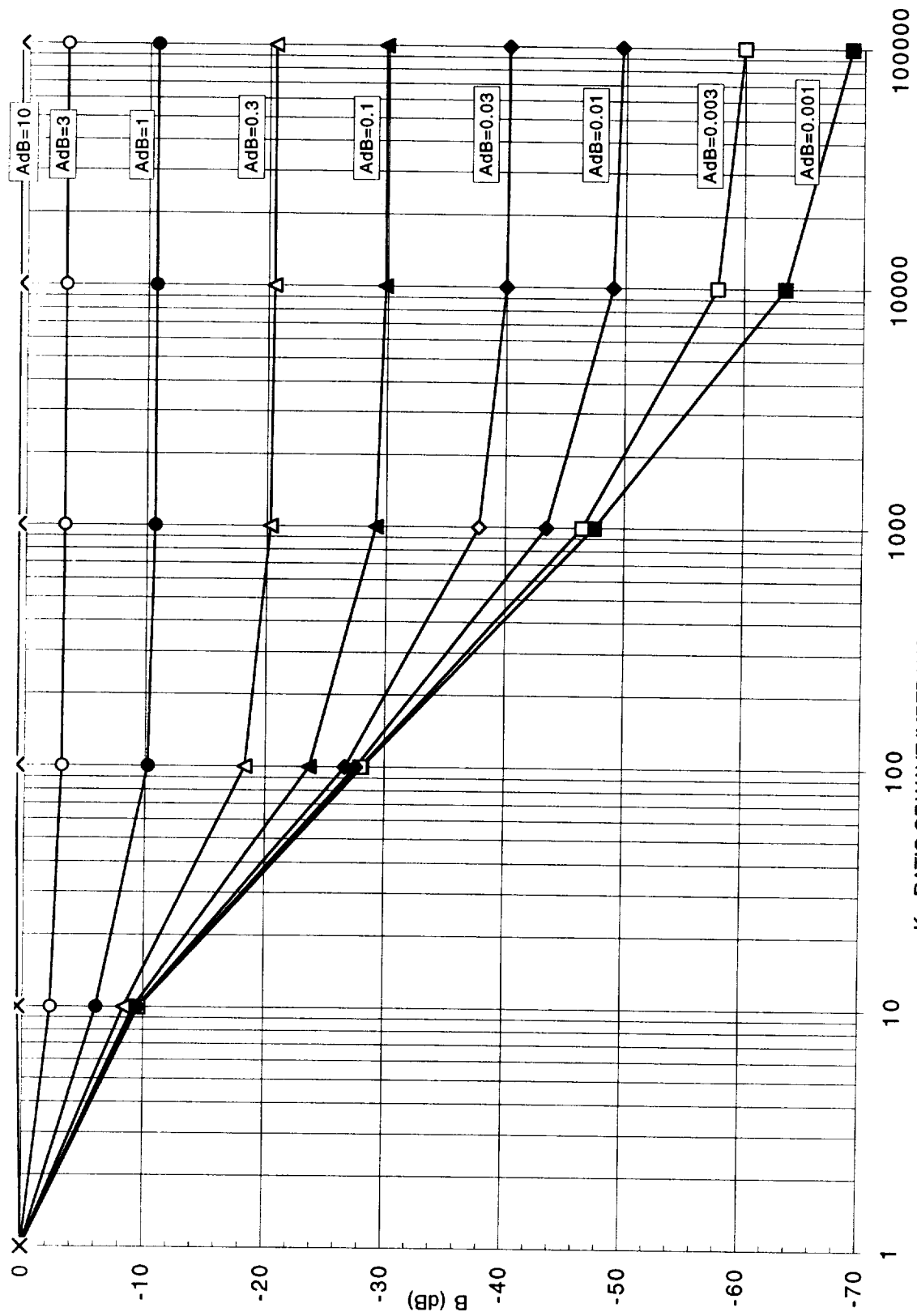

K = RATIO OF WAVE IMPEDANCE TO MATERIAL IMPEDANCE

Figure 5. - Rereflection Coefficient B(dB).

5.2.1 Outline of Method for Calculating Shielding Effectiveness of Metal or Other Conductive Materials

General equations for SE have been given in the previous section. Certain special equations that require fewer calculations, but have restrictions on their use, are available in references 3, 4, 5, and 6. The number of SE equations, and the many restrictions of the special equations, become somewhat confusing to the person trying to make a quick calculation of SE. However, the outline given here for calculating SE of a solid sheet or panel can be used for any metal or other conductive material with very few restrictions. The following steps for SE calculation are given in their proper order:

- (1) The constants required are: r , t , μ_r , σ_r , and Z_s .

r = distance from radiating source (meters). If unknown, use a large default value for a plane wave calculation.

t = thickness of metal or conductive surface in meters and in centimeters.

$\mu_r = \frac{\mu}{\mu_o}$ = permeability of the conductive material relative to air.

μ = absolute permeability of material

$\mu_o = 4\pi \times 10^{-7}$ = permeability of air (henries per meter)

$\sigma_r = \frac{\sigma}{\sigma_{cu}}$ = conductivity of material relative to copper

$\sigma = \frac{1}{\rho}$ = absolute conductivity of material

$\sigma_{cu} = 5.8 \times 10^7$ = conductivity of copper (mhos per meter)

$\rho = R_s \times t_m$ = volume resistivity (ohm-meters)

R_s = surface resistivity (ohms per square)

Z_s = estimated source impedance

(2) Choose specific frequencies (MHz) across the frequency range of interest.

Calculate the following at each frequency. A table including results of each calculation helps keep things organized:

(3) $\lambda = \frac{300}{f_{\text{MHz}}} = \text{wavelength (meters)}$

(4) $\delta = \frac{0.0066}{\sqrt{\mu_r \sigma_r f_{\text{MHz}}}} = \text{skin depth (centimeters)}$

(5) $\frac{t}{\delta} = \text{ratio (use same units for each)}$

(6) $Z_m = 369 \sqrt{\frac{\mu_r}{\sigma_r}} (f_{\text{MHz}}) \times 10^{-6} = \text{impedance of material when } \frac{t}{\delta} \geq 3$

(7) $Z_B = \frac{Z_m}{\left(1 - \frac{1}{e^{\left(\frac{t}{\delta}\right)}}\right)} = \text{impedance of material for any value of } \frac{t}{\delta}$

$e = 2.718$

when $\frac{t}{\delta} \geq 3, (Z_B \approx Z_m)$

(8) $Z_w = k377 = \text{wave impedance (ohms)}$

Where,

$$k = 1 \quad \text{when } r \geq \frac{\lambda}{2\pi}, \quad (\text{for plane waves})$$

$k = \frac{\lambda}{2\pi r}$ when $r \leq \frac{\lambda}{2\pi}$, and source impedance is high;
but Z_W cannot exceed source impedance.

$k = \frac{2\pi r}{\lambda}$ when $r \leq \frac{\lambda}{2\pi}$, and source impedance is low,
but Z_W cannot be lower than source impedance.

$$(9) \quad K = \frac{Z_W}{Z_B}, \text{ ratio (both in ohms)}$$

$$(10) \quad R_{dB} = 20 \log \frac{(K + 1)^2}{4K}$$

$$R_{dB} = 20 \log \frac{K}{4}, \text{ when } K \gg 1$$

$$(11) \quad A_{dB} = 1314 t_{cm} \sqrt{f_{MHz} \mu_r \sigma_r}$$

or,

$$A_{dB} = 8.7 \left(\frac{t}{\delta} \right)$$

$$(12) \quad B_{dB} = 20 \log \left[1 - \left(\frac{K - 1}{K + 1} \right)^2 \times 10^{-0.1 A_{dB}} (\cos 0.23 A_{dB} - j \sin 0.23 A_{dB}) \right]$$

or,

$$B_{dB} = 20 \log \left(1 - e^{-2t\sqrt{\pi f \mu \sigma}} e^{-j2t\sqrt{\pi f \mu \sigma}} \right)$$

Where,

f in Hz, μ and σ in absolute units

or, use figure 5, to determine B_{dB} , knowing A_{dB} and K

$$(13) \quad SE_{total} = R_{dB} + A_{dB} + B_{dB}, \text{ add algebraically,}$$

B_{dB} will usually be negative.

5.3 Apertures

The methods of calculation presented so far have concentrated on the SE of a solid sheet or panel of conductive material. Typical equipment cases and spacecraft skins have apertures such as windows, vents, seams, and joints that degrade the SE of the conductive material. In such cases, a special method for calculating the SE of the structure is necessary. First, calculate the SE for a panel of the conductive material at each frequency of interest. Second, calculate the SE of the aperture at each of the same frequencies. Then use the lower SE value at each frequency.

Usually, there are several types of apertures. The method of combining their effects is similar to the method of calculating total resistance produced by several parallel resistors:

$$\frac{1}{SE_{\text{total}}} = \frac{1}{SE_1} + \frac{1}{SE_2} + \frac{1}{SE_3} \dots \quad (17)$$

However, since the SE is stated in dB, each SE must be converted back to a ratio before adding. The total SE is then converted back to dB. The total SE of several apertures will be somewhat less than the lowest individual SE.

The following paragraphs demonstrate the methods for determining individual SE for various types of apertures.

5.3.1 Shielding Effectiveness of a Conductive Panel With Apertures

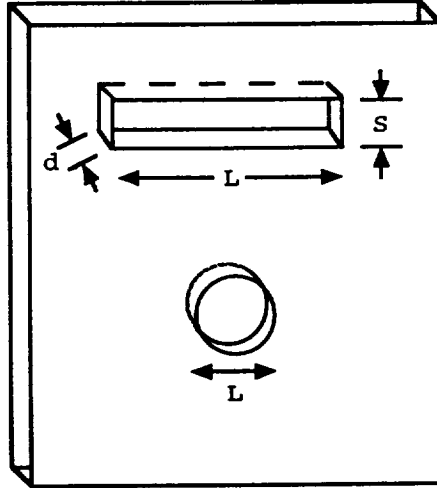

Figure 6. - Aperture Dimensions

For a rectangular shaped slot as shown in figure 6: [4]

$$SE_{dB} = 97 - 20 \log(Lf_{MHz}) + 20 \log \left[1 + \ln \left(\frac{L}{S} \right) \right] + SE_{shad} + 30 \left(\frac{d}{L} \right) \quad (18)$$

Where,

L & S = slot length and height (mm)

d = depth of slot, usually thickness of material (mm)

SE_{shad} = shadow effect, see table 3, or default to 3_{dB} .

ln = natural log

For a circular hole as shown in figure 6: [4]

$$SE_{dB} = 99 - 20 \log(Lf_{MHz}) + SE_{shad} + 30 \left(\frac{d}{L} \right) \quad (19)$$

Where,

L = diameter (mm)

In both cases, if the panel is thin ($d \ll L$), the last term approaches zero. This is the absorption term.

The shadow effect occurs when the slot is in one conductive wall of an otherwise enclosed box. The shadow effect depends upon the size of the slot, the dimensions of the box, and the frequency. In effect, the slot reradiates inside the box. This produces a pattern of lobes and nulls that scatter the incoming energy. The shadow effect is the integrated value of this pattern of lobes and nulls inside the box. It reduces the field intensity from the peak value received. Table 3, shows typical values of additional shielding due to shadow effect for various box and slot dimensions. Typical boxes will have less than 5 dB attributed to the shadow effect. Thus, 3 dB is a good default value for use in the equation.

At low frequencies the equation will produce values that appear to exceed the SE of a solid panel. At this point the solid sheet SE becomes the upper limit.

It should be noted that any opening, such as the small gap created by a poor contact at a joint, can be considered a slot.

At high frequencies or for long slots when $L \geq \frac{\lambda}{2}$, assume zero dB shielding.

Table 3. Additional Shielding Effectiveness Due to Shadow Effect (dB) [2]

L/W	S/H	D/W						
		0.1	0.2	0.3	0.5	1.0	1.5	2.0
0.01	0.01	10	7	6	5	3	2	1
0.01	0.20	9	7	6	5	2	2	1
0.01	0.40	6	5	5	4	2	1	1
0.01	0.60	2	3	3	3	2	1	1
0.01	0.80	1	0	0	1	1	1	1
0.2	0.01	10	7	6	5	3	2	1
0.2	0.20	9	7	6	5	2	2	1
0.2	0.40	7	6	5	4	2	2	1
0.2	0.60	2	3	3	3	2	1	1
0.2	0.80	1	1	0	1	1	1	1
0.4	0.01	10	7	6	5	3	2	1
0.4	0.20	8	6	6	5	2	2	1
0.4	0.40	6	6	5	4	2	1	1
0.4	0.60	3	4	4	4	2	1	1
0.4	0.80	1	1	1	2	1	1	1
0.6	0.01	10	7	6	5	3	2	1
0.6	0.20	6	6	5	4	2	2	1
0.6	0.40	4	4	4	4	2	1	1
0.6	0.60	2	3	3	3	2	1	1
0.6	0.80	2	1	2	3	2	1	1
0.8	0.01	10	7	6	5	3	2	1
0.8	0.20	5	5	5	4	2	1	1
0.8	0.40	2	3	3	3	2	1	1
0.8	0.60	1	1	2	2	2	1	1
0.8	0.80	1	1	1	2	1	1	1
1	0.01	10	7	6	5	3	2	1
1	0.20	3	4	4	4	2	1	1
1	0.40	1	1	2	3	2	1	1
1	0.60	1	1	0	1	1	1	1
1	0.80	1	0	0	0	1	0	0

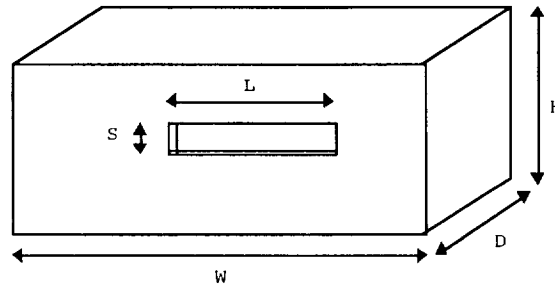

W = Box Width L = Slot Length
H = Box Height S = Slot Width
D = Box Depth

5.3.2 Shielding Effectiveness of Panel With Subdivided Aperture

To calculate the SE of a panel with a subdivided aperture; first, calculate the SE of a panel with one aperture as large as the outline of the outer edge of the smaller apertures as shown by the dashed line in figure 7. Then, using equation 20, calculate the improvement (ΔSE) caused by subdividing the large hole into smaller holes. Add the improvement to the original calculation to get total SE. [4]

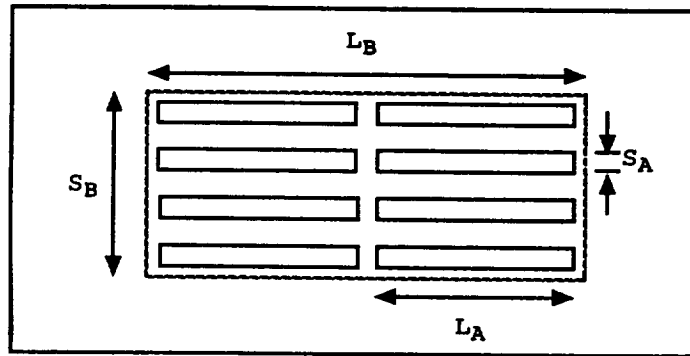

Figure 7. - Subdivided Aperture

$$\Delta SE = 20 \log \left(\frac{L_B}{L_A} \right) - 20 \log \left[\frac{1 + \ln \left(\frac{L_B}{S_B} \right)}{1 + \ln \left(\frac{L_A}{S_A} \right)} \right] \quad (20)$$

Where,

L_B and S_B = slot length and width before subdividing

L_A and S_A = slot length and width after subdividing

Note: If the original hole is subdivided into smaller holes with the same L/S ratio as the original, the second term disappears.

5.3.3 Shielding Effectiveness of Wire Screens or Conductive Meshes

For plane waves, where $r \geq \frac{\lambda}{2\pi}$, [4]

$$SE = 20 \log \left(\frac{\lambda/2}{g} \right) \text{ dB, for } g \leq \frac{\lambda}{2} \quad (21)$$

$$SE = 0, \quad \text{for } g \geq \frac{\lambda}{2}$$

Where,

r = distance from source to screen (meters)

λ = wavelength (meters)

g = distance between wires (meters) as shown in figure 8

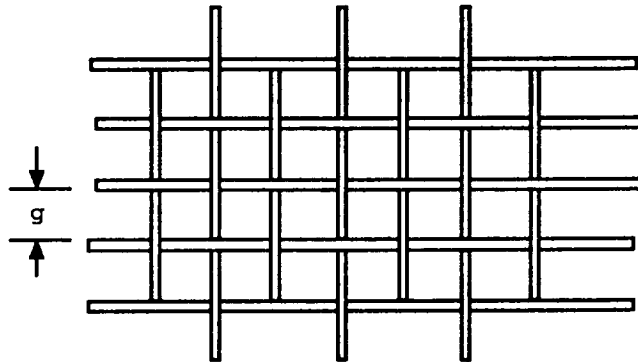

Figure 8. - Wire Screen

For near fields, where $r \leq \frac{\lambda}{2\pi}$, [4]

Magnetic fields:

$$SE_H = 20 \log \left(\frac{\lambda}{2g} \times \frac{2\pi r}{\lambda} \right) = 20 \log \left(\frac{\pi r}{g} \right) \quad (22)$$

Electric fields:

$$SE_E = 20 \log \left(\frac{\lambda}{2g} \times \frac{\lambda}{2\pi r} \right) = 20 \log \left(\frac{\lambda^2}{4\pi r g} \right) \quad (23)$$

or, SE can be calculated for plane waves using equation 21:

$$SE = 20 \log\left(\frac{\lambda}{2g}\right)$$

then add:

$$20 \log\left(\frac{2\pi r}{\lambda}\right) \quad \text{for near magnetic fields} \quad (24)$$

or, add:

$$20 \log\left(\frac{\lambda}{2\pi r}\right) \quad \text{for near electric fields} \quad (25)$$

Neither can be higher than the SE of an equivalent thin metal panel.

These equations are valid when $g \geq 10^{-6}\lambda$. When g is a tiny fraction of a wavelength, such as $g \leq 10^{-6}\lambda$, the screen looks like a solid piece of thin metal. Therefore, the conductive material equations should be used for both near field and far field calculations. Use material conductivity equal to that of the wire material times its percentage of optical coverage.

5.4 Summary of Shielding Effectiveness Determination

The previous sections provide methods for calculating SE of flat panels with and without holes assuming no leakage around the panel edges. The holes degrade the SE at higher frequencies for composites and metals. The limiting factor at the lower frequencies is the SE of the material itself. The SE of the material is generally dependent upon the conductivity of the material and the thickness of the panel.

Table 4 summarizes the method for determining the SE of a panel or an enclosure.

Table 4. Steps to Determine Total Shielding Effectiveness

- To determine total SE, determine the SE of the material and the SE due to apertures across the frequency range. Then use the lower of the two at each frequency as the result.
- To determine the SE of a material, use figure 3 for a quick estimate. If more exact values are required, use equations in the "Outline of Method for Calculating SE" in paragraph 5.2.1.
- To determine SE due to apertures use equations 17 through 25 as applicable.

The methods described in the previous sections were used to calculate the SE of several typical materials and the SE due to slots in conductive materials. Figure 9 shows plots of calculated SE values for several materials and thicknesses. As noted earlier, at low frequencies the SE of materials is the limiting factor, and at higher frequencies the slots cause increasing leakage and become the limiting factor. The plot shows that metals, such as copper and aluminum, make very good shields. When the metals have thicknesses that give good mechanical strength, there is no need to be concerned about the SE of the metal. Notice, however, that the composite materials in our examples -- graphite filament reinforced plastic (GFRP) and steel filaments embedded in plastic -- may not provide adequate SE with their assumed conductivity. Thus, increasing conductivity of composite materials should at least be an important design consideration. The zinc plated plastic, even though thin, is conductive enough to have fairly good shielding characteristics. The primary point of figure 9 is that conductivity is the most important factor in the SE of materials.

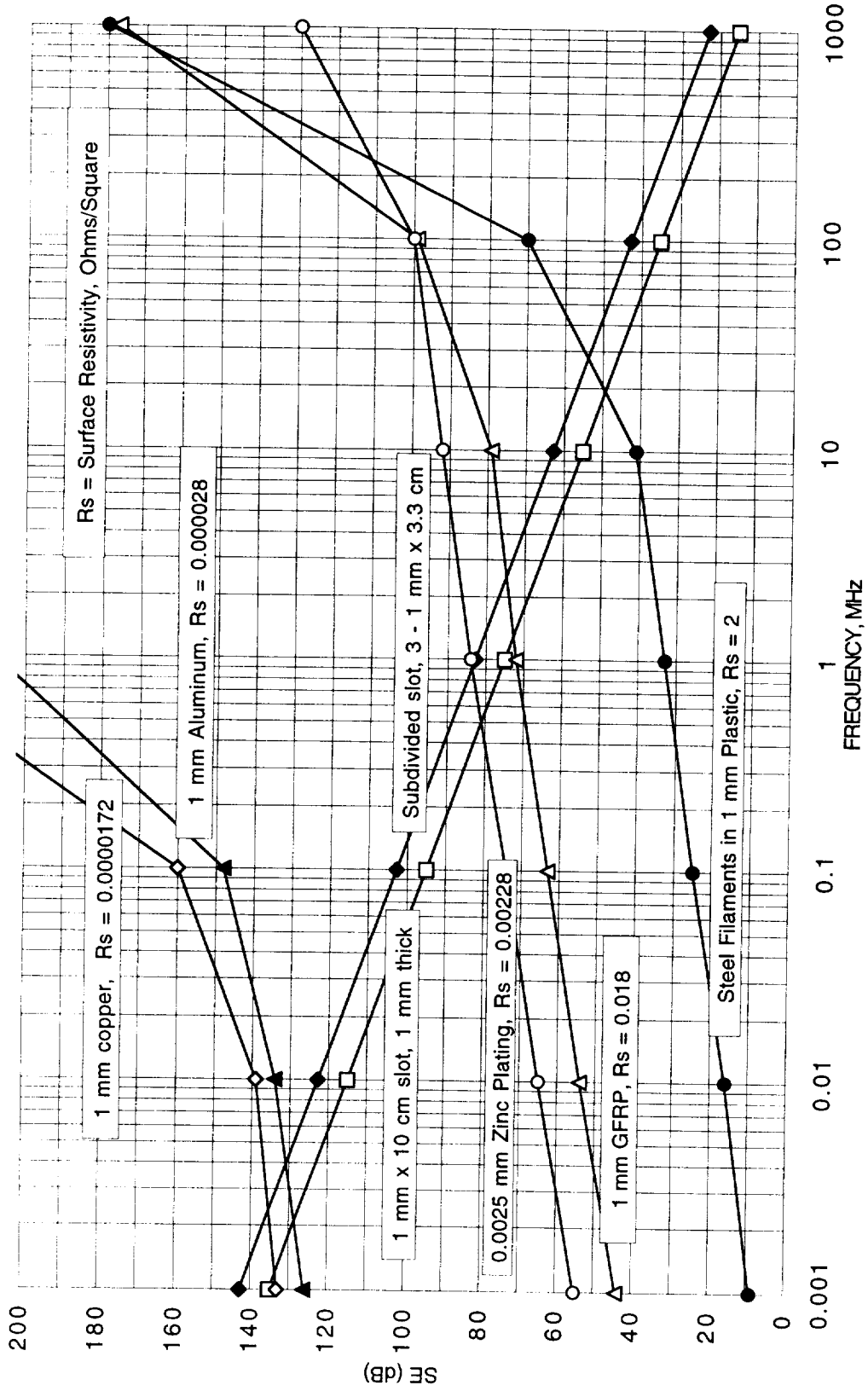

Figure 9. - Examples of Shielding Effectiveness of Materials and Slots

6.0 CURRENT CARRYING CAPABILITY

The current carrying requirements of materials vary considerably depending upon the effect being considered. This section will review the ability of composite materials to meet several EMC related requirements and will provide suggested enhancements where needed.

Attention must be given to joint preparation and electrical bonding to maintain conductivity when using metallic structures. Even more attention must be given to semiconductive materials such as graphite fiber reinforced plastic (GFRP). Making good contact across joints in conductive composites is more difficult than in metals because their surfaces are typically poor conductors. Good contact must be made to the conductive particles or layers within the composite.

6.1 Electrostatic Discharge (ESD) Protection

Nonconductive materials such as fiberglass, rubber, Beta cloth, Kapton, Kevlar, and Teflon retain electrostatic charges on their surface when exposed to any charging mechanism. When any of these materials is used as reinforcement in nonconductive plastic to form a composite material, the composite is very susceptible to electrostatic charging. Composites of this type should not be used in areas where static charging may be a problem.

Dissipation of electric charge does not require high current flow. Resistivity of 10^2 to 10^7 ohms/square in any material is considered statically dissipative. An electric charge can readily progress along the surface and dissipate in a short time. This relatively high resistivity can easily be obtained in composite materials by using graphite fabric, by compounding carbon fiber or flakes, or by using any other filler as conductive as carbon. The conductivity of typical graphite epoxy composite material is adequate for electrostatic charge dissipation if provisions are

made for electrical bonding between conductive filaments and basic structure. The nonconductive plastic outer surface of some graphite fiber reinforced plastic presents a problem when it is exposed to a charging mechanism. Therefore, it may require an additional conductive coating to prevent charge buildup.

The class S bonding requirement of Mil-B-5087 addresses the dissipation of electrostatic charge across joints. It requires a conductive connection between basic structure and any conductive items that may develop an electrostatic charge. It specifies a resistance less than one ohm across each joint. This limit is easy to meet with almost any connection between metal plates, and this is probably the reason one ohm was selected. Connections between composite materials may require more effort to meet the one ohm requirement. In reality a much higher resistance limit could be used for static charge dispersal. A limit of 1×10^6 or 1×10^7 ohms is adequate for most installations.

Nonconductive composite materials should not be used where a charge may develop. If nonconductive materials are unavoidable, a conductive coating should be used. The conductive coating should make a conductive connection to basic structure to drain off any charge that develops. Graphite epoxy material is conductive enough to drain off static charge if the graphite material makes contact across joints to the basic structure. Sanding of nonconductive epoxy coatings on mating surfaces of graphite material may be necessary to obtain the required conductivity across joints.

6.2 Radio Frequency (RF) and Shielding

Graphite epoxy materials are conductive enough to provide some SE. Conductivity varies with graphite content, and the conductivity required depends upon the amount of shielding desired and the frequencies of interest. SE of materials based on their conductivity may be determined by using the quick estimate of figure 3 or by more exact calculations of paragraph 5.2.1 as stated in table 4.

Generally the limitations of conductivity for RF are due to inductive reactance at higher frequencies and not due to high currents through resistive elements. According to reference 8, tests showed that leakage of RF through simulated GFRP aircraft skin was dominated by joints. These joints act like slots if there is not a good conductive contact along the mating surfaces.

Typical values of resistance across commonly used GFRP joints are 50 to 100 milliohms. The class R bonding requirement of MIL-B-5087B is intended to provide a low impedance return path for RF. Since it is difficult to perform RF impedance tests in the field on joints of various configurations, the only test requirement is for a dc resistance less than 2.5 milliohms across each joint. For radio frequencies (RF) the inductive reactance of the joint configuration will likely be higher than the dc limit. The exact RF limit is not specified, but care must be taken to assure low inductance across the joint to provide the lowest impedance possible.

Tin or other metal plating or conductive paint on GFRP can aid conductivity through joints, especially if the surface of the GFRP is sanded lightly to expose the graphite. The conductive surface is spread over a larger area and more layers of graphite are in contact with the better conductor. The plated or prepainted surfaces are mated by overlapping at the joint or by butting the sections together and bridging the joint with metal foil or screen. The use of conductive paint on sanded surfaces seems to make the best joint for RF purposes. For shielding purposes the contact between painted surfaces along the joint must be continuous, or nearly so, with no long gaps between contacts. The acceptable length of the gap depends upon the amount of shielding required and the frequency being shielded. SE can be determined by assuming the gap is an aperture as defined in section 5.3.1.

6.3 Antenna Ground Plane

Some types of antennas are made to operate with a conductive ground plane. Image currents in an antenna ground plane are typically very small, and antenna performance is not degraded by a uniform graphite epoxy ground plane. However, the graphite epoxy cannot be used as a driven element. [7]

The surface resistivity of typical conductive composite, GFRP, is less than one ohm per square. This conductivity is usually adequate for an antenna ground plane. Discontinuities at a seam could cause perturbations, so gaps and joints should be bridged with conductive material such as aluminum tape. A good contact between the antenna base and the conductive composite is required for some types of antennas. [8]

6.4 Fault Current

Results of this review indicate that composite materials used in aerospace work will probably be some form of graphite reinforcement in plastic. The most common form consists of layers of woven graphite fabric embedded in epoxy resin. The graphite may also be in a unidirectional tape form. Other graphite reinforcement includes graphite fibers and nickel coated graphite fibers in epoxy resin. Composites using other reinforcements will be more conductive if metals are used, or highly resistive if nonconductive fillers, such as fiberglass, are used.

When high current flows through GFRP, ohmic heating above 65°C can cause changes in the resistivity of GFRP. This probably occurs because heating the plastic relaxes contact between the graphite fibers. Since resistivity is 1000 times greater for GFRP than for aluminum, greater temperature rises will occur than would be expected with metal. Therefore, intentional returns for power or signal circuits should not be carried through GFRP.

Metallic electronic boxes should be electrically bonded to the basic metal structure to provide a fault current return path in case of a short to the box. A fused power line will protect

against hazardous voltages resulting from shorts to the metal case of equipment when the metal case is connected to the source ground through metallic structure or a "green wire" safety conductor. However, the green wire will not protect against shorts to GFRP structure. The GFRP will have enough resistance to limit fault current to some specific level. This level may be lower than the level required to blow a standard circuit breaker or fuse. The current probably will still be high enough to cause fire in the GFRP. Tests of composite material made of Hercules IM7 fiber and Hercules 8552 resin showed that current above 5 amps produced hot spots that burst into flame. Similar results were obtained using Amoco T300 fiber in Thiokol TCR resin and Hercules AS4 fiber in Hercules 3501 resin. [9]

Composite materials should have good conductive joints to carry small currents for other purposes; but, if any part of the return path for fault current must be through GFRP, standard or slow blow fuses or circuit breakers should not be relied upon for protection. Ground fault circuit interrupters may be used in some cases. They will detect a difference between outgoing and returning current and can be selected to break the circuit below a hazardous current level.

Mil-B-5087 requires joint resistance not to exceed 0.1 ohm for fault current paths. This is meant for highly conductive metallic structures only. Joints between GFRP panels can easily exceed this value, and the GFRP panel itself may have resistance exceeding this limit.

Joints using conductive paint can be conductive enough to carry small fault currents if a large enough area of contact is used. However, we have seen that fault current over 5 amps through a 0.003 square inch contact (the end of a # 14 wire) usually starts a fire at the contact point on several types of GFRP. This can also happen at a joint if the contact area is restricted to a small point. Since it is difficult to avoid this fire hazard, graphite epoxy should not be relied upon to carry fault current from electrical shorts to metallic structure or within electronic equipment. The design should avoid the

possibility of an electrical short directly to GFRP. If fault current paths through composite material cannot be avoided, the particular material should be tested for current carrying capability. Charring and possible fire can be expected at the shorting point in most cases. However, tests performed on a sample of Space Shuttle External Tank nose cone material, Cytec Rigidite 506 Graphite-Phenolic Prepreg, did not burst into flame with up to 33 amps of short circuit current. This indicates that some composite materials with high temperature resin could carry reasonable amounts of fault current without burning.

6.5 Lightning Protection

6.5.1 Environment

Lightning strikes originate most commonly from electrical charging within cumulonimbus thunderclouds. They can also occur in snowstorms, around volcanoes, or other atmospheric turbulence with particles. Lightning may be cloud to ground, cloud to cloud, or between pockets of opposite charge within clouds.

At some point in the electrification of the cloud, a discharge towards the earth takes place. A typical cloud to ground strike begins with a slow moving column of ionized air called a pilot streamer. The charge in the streamer is reinforced by a more intense discharge called the stepped leader. This occurs every 50 meters or so. As the leader approaches the ground, objects on the ground develop an opposite charge that eventually becomes high enough for a streamer to start working its way toward the approaching leader. When these two meet, the path from cloud to ground is highly ionized and provides a low resistance path for the return stroke. This is the intense flash normally seen in a cloud to ground lightning stroke. A charged pocket in the cloud is discharged through the return stroke, and produces peak current levels up to 200 kiloamps. Other charged pockets in the cloud may take the same path to cause multiple

strokes with less current than the first return stroke and all occurring within a second or two.

The ground takes a charge opposite that of the cloud directly above it. Most cloud to ground strikes occur between the negatively charged lower portion of the cloud to the positive ground, but they can occur between a positively charged portion of the cloud to negative ground. Intracloud lightning develops in a similar manner but occurs between oppositely charged pockets within the cloud. Aircraft and rockets may trigger strikes on occasion. The polarity, the path, or whether it is triggered makes little difference to any aircraft or launch vehicle that is in the path of a strike even though amplitudes may be less for triggered strikes.

When struck by lightning, an aircraft or launch vehicle becomes part of the path for the high current. There will be an attachment point and an exit point usually at extremities on the vehicle. Both of these points may move along the surface or reattach at a series of points on moving vehicles.

6.5.2 Specifications

Lightning protection of NASA launch vehicles began with the simple requirement to have metallic skin thick enough to avoid burn-through at lightning attach points and to electrically bond all metallic skin and structure together. The idea was to keep the high amplitude, high frequency current on the surface of the vehicle and direct it around all critical electronic circuitry within the vehicle. This plan was adequate to save the Apollo 12 flight when it was struck by lightning during launch. The Saturn instrument unit was protected by well-bonded vehicle skin. The dumping of computer data in the Apollo spacecraft did point out that vehicles with wiring exposed through apertures were susceptible to lightning upset.

The Space Shuttle obviously would have apertures; and the Shuttle Lightning Criteria Document, JSC 07636, later NSTS 07636, was developed to be used as a requirement on all shuttle elements.

The idealized lightning current waveform developed for this document by the lightning community became the standard, with several modifications, for later lightning protection specifications. [10]

The standardized lightning environment consists of a combination of current waveforms that represent the important characteristics of a lightning strike. These waveforms consist of components "A", "B", "C", "D", and "H":

Component "A" -- high peak current of 200 kA and an action integral of $2 \times 10^6 \text{ A}^2 \text{ s}$

Component "B" -- intermediate current with average amplitude of 2 kA and charge transfer of 10 coulombs

Component "C" -- Continuing current of 200 to 800 amps for up to one second to deliver 200 coulombs

Component "D" -- Restrike current of 100 kA and an action integral of $0.25 \times 10^6 \text{ A}^2 \text{ s}$

Component "H" -- Fast rise time of $2 \times 10^{11} \text{ A/s}$ and a peak of 10 kA

These current wave forms are used in conjunction with strike zone locations to define design requirements for vehicle skin, structure, and equipment.

The action integral is the integral of the current squared multiplied by the time. It is an indicator of the energy contained in the strike.

Strike zone locations are defined depending upon the likelihood of a strike to the location and the possibility of the initial attachment hanging on in the same location. Zones depend upon the vehicle's configuration and orientation and may vary between vehicles. The zones to be defined are as follows:

Zone 1A: Initial attachment point with low possibility of lightning channel hang-on

Zone 1B: Initial attachment point with high possibility of lightning channel hang-on

Zone 2A: A swept stroke zone with low possibility of lightning channel hang-on

- Zone 2B: A swept stroke zone with high possibility of lightning channel hang-on
- Zone 3: Portions of the vehicle between the other zones that may carry substantial amounts of current due to lightning strike to one of the other zones

6.5.3 Direct Effects

Physical damage to a vehicle resulting from a strike is called a direct effect of lightning. This damage may be sustained in several ways including:

- Melt through and pitting at attachment and exit points
- Magnetic force from high current
- Pitting at structural joints due to high current density
- Resistive heating of conductors
- Shock from expansion of the leader and return stroke path

Vehicles with metal skin and structure of sufficient thickness to withstand heating and shock at lightning attachment and exit points have little trouble withstanding the other direct effects hazards except at poorly bonded joints where current density and resistance combine to cause hot spots.

Outer surfaces made of nonconducting material may have problems when streamers from underlying conductors penetrate the material. The shock from the outward expansion when the return stroke tries to penetrate the material along the streamer path can result in severe damage. Non-conductive homogeneous materials usually resist penetration by the streamer much better than nonconductive layered composite material can. This is probably due to tiny holes or paths at the plastic-to-reinforcement interface that reduces the dielectric strength of the composite.

The shock effect of a direct strike may shatter a conductive composite. Resistive heating at attachment and exit points vaporizes the carbon fibers and ignites the plastic. The high current produces enough heat to cause the resin and carbon fiber to disintegrate. The result, depending upon the amount of current

in the strike, is usually a burned hole through several layers of laminate with charring for several inches around the contact point. This direct effect to a launch vehicle is clearly unacceptable in most cases. Graphite epoxy seems to be able to carry a considerable amount of current after it gets dispersed throughout the material. The problems occur at restrictions where the high density current causes heating to the ignition point. This can happen at riveted or bolted joints as well as at the attachment and exit points mentioned above. [10 & 11]

6.5.4 Indirect Effects

Even when lightning does not make direct contact with the vehicle's wiring or electronic systems, it can cause voltage and current surges in the wiring that may affect electronic equipment at any location.

Magnetically induced currents are caused by a magnetic field surrounding the lightning current as it flows along the vehicle skin. This field changes rapidly and induces currents into any wiring that may run parallel to the lightning current.

Voltage differences also develop between different parts of the vehicle structure because of the high current through the structure and the impedance of the structure and joints between parts of the structure. Any wiring connected to structure takes on the voltage of the structure at that point. There will be a voltage difference between the wire and structure at other locations.

Well-bonded aluminum structures are very conductive, and with a little attention, standard construction techniques can make good conductive joints that will keep this voltage fairly low. Materials of higher resistivity and poorly bonded joints increase the problem. Graphite epoxy material has resistivity approximately 1000 times that of aluminum and requires special effort for lightning protection.

6.5.5 Protection

The most direct way to protect metal against melt through is to provide adequate thickness. For unpainted aluminum this usually means 0.125 to 0.250 inches thick. This thickness can take 25 to 50 coulombs (1000 amps for 50 milliseconds). Painted metal may require greater thickness than unpainted to withstand the same strike. Painted surfaces tend to cause the strike to hang on to the same point longer on a moving vehicle. Zone locations and the lightning environment to be encountered at specific locations are to be determined before specific design requirements can be defined.

Another method of protecting against melt through is to use two layers of laminated metal. In laboratory tests the top layer is burned away at the strike point but the lower layer remains intact. A laminate of one 0.020 inch layer and one 0.030 layer separated by nonconductive adhesive can withstand the same strike as one 0.080 inch layer. [10]

Joints between metal panels must be well bonded to carry the lightning current without arcing or burning the metal. To be electrically bonded, the contact along the joint should be continuous or at least have many connections along the joint. Connections through surfaces held together with many rivets or bolts are typical and usually are adequate for aluminum. Relying on bond straps is risky because the straps are usually too few and too far apart and the strap has some inductance that will present impedance to the sharply rising current. This is so even though the dc resistance across the joint might lead the unsuspecting person to believe he has a good bond.

Nonconductive material on the outside of a vehicle may find itself in the path of a lightning strike. Since these materials will not conduct lightning current, a strike to an exposed nonconductor has two route choices. As noted earlier, a streamer from an underlying conductor may make its way through the nonconductive material, and the resulting strike tries to go through the same tiny path with explosive results. If the

material has a high dielectric strength, a path across the surface to a nearby conductor may have lower impedance than the short path to the underlying conductor. While this current across the composite may cause indirect effects to underlying equipment, it is still preferable to the explosive route. Nonconductive composites should not be used on the exterior of a vehicle if puncture and damage are unacceptable. However, if its use is unavoidable, efforts should be made to enhance the tendency to divert the strike across the material. This is done by attaching conductive diverter strips across the material or by covering the material with a conductive layer.

The conductive metal strips should be close enough together to make sure the strike will flash across the surface to a diverter rather than puncturing the nonconductive composite and striking conductive equipment underneath the material. This distance depends upon the dielectric strength of the material and the distance to the underlying equipment. Diverters should not be so long that their inductive reactance provides an impedance greater than the punch through impedance of the material. Typical separation distance between diverters is from 12 to 24 inches. They should be firmly fastened to prevent magnetic forces from tearing the metal strips loose and damaging nearby material. [10]

Conductive layers may be used where electromagnetic or visual transparency is not required. These layers may be thin like solid metal foil, woven metal fabric, or expanded metal foil. Any of this group may be cemented over the nonconductor or they may be formed as outer layers of the composite material. The thin layers act as guides to lead the strike along the surface of the material. They will be melted away at the lightning strike point, but they still serve their purpose of protecting underlying equipment especially if another metal layer is used on the inside.

Where visual transparency is required, small conductive tabs or dots may be placed on the surface such that the lightning arc is guided down the row of dots to basic structure. Once the path is made, the arc will sustain itself long enough to carry most of the current. In this case underlying electronic equipment must

be kept away from the non-conductive material to assure the arc from dot to dot is the path of least resistance.

Conductive composite material usually means some form of graphite epoxy. The graphite layers can carry a substantial current if it can be distributed throughout the material. Direct effect damage to conductive composites results from the shock and heat from the strike entry and exit points and from heating and arcing at joints or other restrictions where current density is high. Typical damage to graphite epoxy consists of disintegration of graphite and epoxy at the strike point and splitting or fraying of fibers leading away from the strike point due to the initial shock from the high current and fast rise time. Burning of several layers of material occurs due to high heat transfer during the continuing current portion of the lightning strike. [11]

Protection of conductive composites consists of efforts to disperse the lightning current over a larger area or to provide composite material thick enough to have adequate thickness left after the strike. This becomes critical if the material is a pressure vessel or a fuel container. In this case special tests should be performed on the particular material being used to assure adequate thickness. Methods for protection against direct effects should include an outer layer of metal screen, foil, or expanded foil cured into the laminate and making contact with the graphite where possible. The metal layer should be well bonded to the basic metallic structure. The metal helps disperse the current over a larger area while holding temperature of the composite at a lower level. The metal can be expected to be vaporized near the strike point, but much less damage is done to the graphite epoxy material. The metal used is usually 2 to 4 mils thick. By comparison, aluminum skins are sometimes punctured even though they are 1/8 to 1/4 inches thick. [11]

Wire mesh may be made of wire as fine as 0.002 inches spaced up to 200 per inch. Solid or expanded metal foil may be 0.001 inch or thicker. Expanded metal is easier to shape around sharp bends and compound curves.

Table 5 shows the direct strike damage done to 12 inch squares of various GFRP samples when they were struck by simulated lightning components "A" and "C".

TABLE 5. - Damage from Direct Strike [11]

- 1. Expanded metal on both sides of GFRP (0.098 inch)**
"A" Component Damage: Burned 1.5 inch diameter hole in foil, and 1 inch diameter spot on GFRP.
"C" Component Damage: Burned through 1 to 3 layers of GFRP.
- 2. Expanded metal on top side of GFRP (0.073 inch)**
"A" Component Damage: Blew off 2/3 of foil, charred 1 inch diameter spot on GFRP, melted 0.5 inch spot on back.
"C" Component Damage: Burned through 3 to 4 layers of GFRP, 1 inch spot melted on back.
- 3. GFRP mat (0.068 inch)**
"A" Component Damage: Burned 2.5 inch to 4 inch diameter spot through two layers of GFRP.
"C" Component Damage: Burned through 2 to 4 layers of GFRP.
- 4. GFRP Unitape (0.062 inch)**
"A" Component Damage: Blew out 4 to 5 single layers of GFRP, frayed 4 inch to 5 inch diameter spot, split and cracked both sides of sample.
"C" Component Damage: Burned through 2 to 4 layers of GFRP, melted up to 1.25 inch diameter spot on back.
- 5. Honeycomb (0.621 inch)**
"A" Component Damage: Delaminated and blew off GFRP panel from back side, expanded aluminum core.
"C" Component Damage: Burned 2 to 3 layers of GFRP on top panel.

The direct effects of lightning can damage conductive composites at joints and at other constrictions in addition to attachment and exit points. Adhesives are usually used at composite material joints. The adhesive is usually nonconductive and often is applied in a layer of nonconductive fabric. Joints should be protected by increasing the electrical contact area along the joint. This may be done by doping the adhesive with conductive particles or by inserting a conductive material within the joint or across the joint. Rivets or bolts may also be used alone or in combination with adhesives.

Conductive adhesives are doped with metal particles usually aluminum or silver. More metal makes the adhesive more conductive, but it also makes the adhesive bond weaker. It is usually better to use regular adhesive to assure good connection and use a side dressing of conductive adhesive to provide conductivity across the joint. The shock effect of a lightning strike tends to forcibly separate joints. Rivets or bolts may be required to help hold the connection together.

A carbon cloth, screen wire, or expanded metal scrim may be applied between overlapping composites with the adhesive. When placed under pressure while hardening, the carbon or metal scrim will contact conductive graphite in both layers and provide electrical contact along the joint. The composite material may need to be sanded to expose the graphite before applying the scrim and adhesive. If conductive contact is not adequate through the scrim, arcing will occur and the joint may be debonded by the resulting pressure.

Bolts or rivets alone may also be used to join two conductive composites. They will provide conductive paths, but the contact from graphite to the fastener is limited to the area under the head and nut. If the composite has a nonconductive outer coating, the conductive area may be increased by using beveled washers and fastener heads in countersunk holes. The number of fasteners required for adequate conductivity is usually found by test of the particular material. If bolts or rivets are the primary method of

holding the panels together, there are usually enough to provide conductivity. Some arcing can usually be tolerated if it is not in an explosive or flammable area. The arcing may do damage to the composite at the contact to the fastener but should not destroy the joint if enough fasteners are used to provide adequate mechanical strength. The use of a combination of conductive adhesive between sanded surfaces and metal fasteners for mechanical strength would seem to be the best method of connection. If mechanical fasteners are used and permanent adhesive connection is undesirable, sanded panel surfaces with coatings of conductive adhesive, separately cured, can be used in conjunction with metal fasteners to make better contact across the joint.

During tests there was no discernable difference in damage when using a lap joint or a butt joint with a 2 inch wide, 0.125 inch thick, aluminum plate across the butt joint. Two bolts held the lap joint together. Two bolts held each sample to the aluminum plate for the butt joint test.

Component "C" did most of the heating type damage at the joint, but there was some splitting of GFRP layers due to the shock effect of component "A".

The GFRP was frayed and charred one layer deep at the mating surfaces on unimproved joints. The fraying was eliminated and the charring reduced by sanding the mating surfaces and painting the sanded area with conductive silver paint. The paint was allowed to dry before joining the samples. [11]

Indirect effects on underlying electronic equipment and circuitry may not be completely negated by the single outer layer of metal. This protection becomes more of a shielding effectiveness problem and may require another layer of foil as an inner layer of the laminate as shown in figure 10. If the shielding layer is required its joints should be carefully connected to prevent long gaps that can allow penetration by RF resulting from the fast rise lightning current. Both layers of foil should be mechanically secure since current may flow in both layers resulting in magnetic forces that tend to separate the layers.

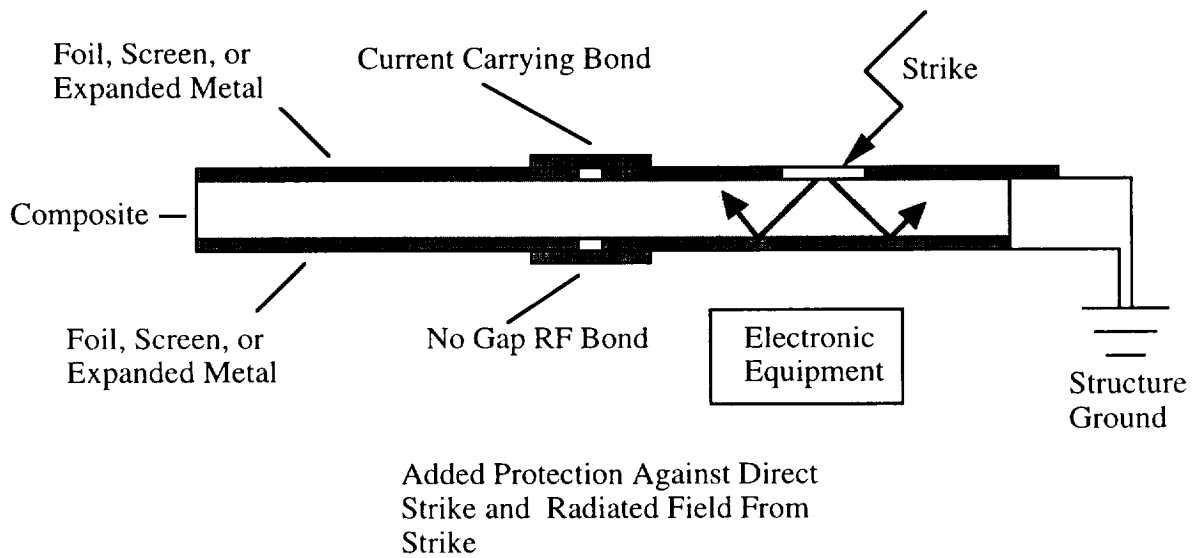
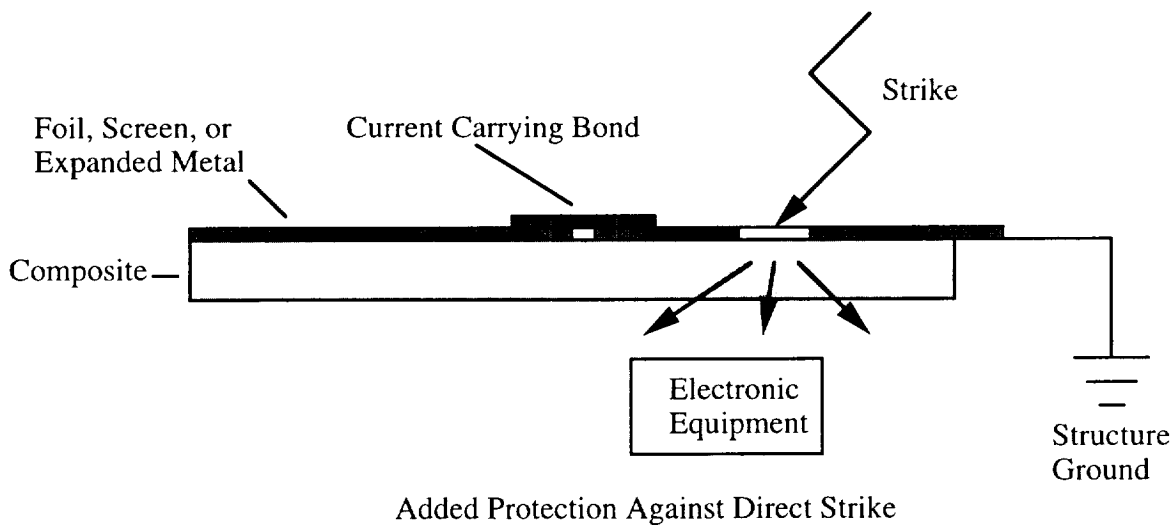

Figure 10 - Lightning Protection

Indirect effects within a vehicle with conductive composite skin are reduced by enclosing all wiring, reducing apertures, and applying good bonding practices at joints just as with metal skin. However, as lightning current flows down the vehicle, more current is distributed inside the composite structure than would be the case with more conductive metal. This results in more current flowing on wiring and metallic structures inside the vehicle. Another phenomenon with poorer conducting composite skin is that current continues to flow inside the vehicle longer than the duration of the lightning strike, whereas with metal skin the current rise and fall inside closely follow the lightning current itself.

Shielding effectiveness tests were performed on several thicknesses of GFRP with various metal enhancements. A large aluminum container with a 10 inch square opening was used to house sensors, and 12 inch square samples were bolted over the 10 inch opening. Simulated lightning component "D" was used to strike directly to the center of the samples and at a remote point 3 meters from the sample. Results of the remote strike test showed that all samples provided at least 30 dB of shielding against electric fields compared to a nonconductive fiberglass sample. Magnetic field rate of change measurements ranged from 30 dB for 0.062 inch thick GFRP to over 50 dB for 0.098 inch GFRP with an expanded aluminum foil layer on each side. When strikes were made directly to the center of the samples, the electric field shielding effectiveness ranged from 40 dB better than fiberglass for 0.062 GFRP to 50 dB for the 0.098 inch GFRP with expanded aluminum foil on both sides. Magnetic field rate of change ranged from 20 dB to 40 dB for the same materials. [11]

These results indicate that GFRP materials can provide some shielding, and they can be enhanced with metal to obtain a significant amount of shielding where required.

6.6 Galvanic Reaction

Since graphite is low in the galvanic series near copper, galvanic reaction between dissimilar materials is a concern. A

potential difference over one volt can be expected between carbon and aluminum. Aluminum or other metal high in the series will corrode when in direct contact with GFRP in the presence of moisture. Graphite epoxy joints can deteriorate rapidly in salt spray conditions. [12] This corrosion in the joint could result in a high resistance contact. It should be treated accordingly. A dielectric coating between materials prevents corrosion but also prevents electrical contact. A metal that is nearer the more active metal in the galvanic series should be used as a conductive coating on the GFRP mating surface. Coat both the GFRP and the more active metal or just the GFRP. Never coat just the more active metal because any contact through a small break in the coating will cause corrosion more severe than through a large contact area. Tin plating or shims between aluminum and GFRP should be satisfactory. Nickel may be used for moderately long term installations if a water tight coating is applied after assembling the joint. Permanent installations with nickel to aluminum may eventually corrode.

6.7 Summary of Protection Methods

Table 6 presents a review of protection methods for various purposes.

TABLE 6. Review of Protection Methods

1. Electrostatic Discharge (ESD):

- Resistivity less than 10^7 ohms is adequate to disperse static charge.
- Assure electrical bond from conductive or semiconductive materials to conductive basic structure.
- Avoid use of nonconductive materials where electrostatic charge can develop and cause problems.

2. RF Shielding:

- Use procedure outlined in table 4 to assure adequate shielding effectiveness.
- Use figure 3 for a quick estimate or use equations of section 5.2.1 for more exact calculation of material SE.
- Use equations 17 through 25 to determine SE due to apertures.
- Reduce apertures to a minimum.
- Close joints in GFRP by use of conductive paint or metal plating over mating surfaces.
- Provide continuous, or nearly continuous, contact between mating surfaces to avoid lengthy cracks.

3. Antenna Ground Plane:

- Composite material with resistivity less than one ohm per square usually is adequate for an antenna ground plane.
- Cover joints with conductive material to avoid large discontinuities.

TABLE 6. (Cont.) Review of Protection Methods

4. Fault Current:

- Avoid use of GFRP for intentional current return.
- Avoid use of GFRP, where possible, for unintentional fault current return.
- If fault current return is unavoidable:
 - Test material to determine current carrying capability.
 - Expect fire and charring at shorting point and at restrictions if more than 5 amps is involved.
 - Do not rely on standard or slow blow fuses or breakers.
 - Use ground fault circuit interrupters.

5. Lightning:

- Avoid nonconducting surfaces on exterior of vehicle.
- If nonconductors are unavoidable, use diverter strips to divert strike to nearby conductive structure.
- Expect extensive damage to GFRP at strike point.
- Use adequate thickness to withstand strike without structural failure.
- Use expanded metal foil on surface to help protect GFRP.
- Use another expanded metal foil on underside and treat it as shielding material to protect against indirect effects.

6. Galvanic Reaction:

- Graphite is low (more negative) in the galvanic series near copper.
- It may be bonded directly to copper or to platings of nickel, tin, silver, or gold.
- When bonding to aluminum use tin or nickel coatings on the GFRP only, or on both surfaces to reduce reaction.
- Do not coat the more positive surface only.
- Preclude moisture from the joint

REFERENCES

1. Clark, T. L., McCollum, M. B., Trout, D. H., and Javor, K.: *Marshall Space Flight Center Electromagnetic Compatibility Design and Interference Control (MEDIC) Handbook*. NASA Reference Publication 1368, MSFC, AL, June 1995.
2. Bull, D. A., Jackson, G. A., and Smithers, B. W.: "RF Resistivity and Screening Characteristics of CFC Materials." NATO Advisory Group for Aerospace Research and Development, Avionics Panel, Conference No. 283, Lisbon, Portugal, June 1980.
3. Violette, J. L. N., White, D. R. J., and Violette, M. F.: *Electromagnetic Compatibility Handbook*. Van Nostrand Reinhold, Co., New York, NY, (1987).
4. White, D. R. J., and Mardiguian, Michel: *A Handbook Series on Electromagnetic Interference and Compatibility, Electromagnetic Shielding*. Volume 3, Interference Control Technologies, Inc., Gainesville, VA, (1988).
5. Keiser, Bernhard: *Principles of Electromagnetic Compatibility*. Artech House, Norwood, MA, (1987).
6. Duff, William G.: *A Handbook Series on Electromagnetic Interference and Compatibility, Fundamentals of Electromagnetic Compatibility*. Volume 1, Interference Control Technologies, Inc., Gainesville, VA, (1988).
7. Blake, C. L.: "Composites - Their Electrical and Electromagnetic Impact." IEEE International Symposium on Electromagnetic Compatibility, Washington, DC, July 1976.

8. Weinstock, G. L.: "Electromagnetic Integration of Composite Structure in Aircraft." NATO Advisory Group for Aerospace Research and Development, Avionics Panel, Conference No. 283, Lisbon, Portugal, June 1980.
9. R. Evans: "Test Report, Fault Current Through Graphite Filament Reinforced Plastic." NASA CR-4774, Marshall Space Flight Center, AL, Sept 1996.
10. Fisher, F. A., Plumer, J. A., and Perala, R. A.: *Lightning Protection of Aircraft*. Lightning Technologies, Inc., Pittsfield, MA, (1990).
11. Evans, R.: "Test Report, Lightning Effects on Composite Materials." NASA CR-4783, Marshall Space Flight Center, AL, Feb 1997.
12. Birken, J.: "In Depth Studies of Composite Aircraft Electromagnetic Performance." NATO Advisory Group for Aerospace Research and Development, Avionics Panel, Conference No. 283, Lisbon, Portugal, June 1980.

REPORT DOCUMENTATION PAGE			Form Approved OMB No. 0704-0188	
Public reporting burden for this collection of information is estimated to average 1 hour per response, including the time for reviewing instructions, searching existing data sources, gathering and maintaining the data needed, and completing and reviewing the collection of information. Send comments regarding this burden estimate or any other aspect of this collection of information, including suggestions for reducing this burden, to Washington Headquarters Services, Directorate for Information Operation and Reports, 1215 Jefferson Davis Highway, Suite 1204, Arlington, VA 22202-4302, and to the Office of Management and Budget, Paperwork Reduction Project (0704-0188), Washington, DC 20503				
1. AGENCY USE ONLY (Leave Blank)	2. REPORT DATE August 1997	3. REPORT TYPE AND DATES COVERED Contractor Report (Final)		
4. TITLE AND SUBTITLE Design Guidelines for Shielding Effectiveness, Current Carrying Capability, and the Enhancement of Conductivity of Composite Materials			5. FUNDING NUMBERS NAS8-39983	
6. AUTHORS R.W. Evans				
7. PERFORMING ORGANIZATION NAMES(S) AND ADDRESS(ES) Tec-Masters, Inc. 1500 Perimeter Parkway, Suite 400 Huntsville, AL 35806			8. PERFORMING ORGANIZATION REPORT NUMBER M-837	
9. SPONSORING/MONITORING AGENCY NAME(S) AND ADDRESS(ES) National Aeronautics and Space Administration Washington, DC 20546-0001			10. SPONSORING/MONITORING AGENCY REPORT NUMBER NASA CR-4784	
11. SUPPLEMENTARY NOTES Prepared for the Marshall Space Flight Center Technical Monitor: Steven Pearson				
12a. DISTRIBUTION/AVAILABILITY STATEMENT Unclassified - Unlimited Subject Category 18			12b. DISTRIBUTION CODE	
13. ABSTRACT (Maximum 200 words) <p>These guidelines address the electrical properties of composite materials which may have an effect on electromagnetic compatibility (EMC). The main topics of the guidelines include the electrical shielding, fault current return, and lightning protection capabilities of graphite reinforced polymers, since they are somewhat conductive but may require enhancement to be adequate for EMC purposes.</p> <p>Shielding effectiveness depends heavily upon the conductivity of the material. Graphite epoxy can provide useful shielding against RF signals, but it is approximately 1,000 times more resistive than good conductive metals. The reduced shielding effectiveness is significant but is still useful in many cases. The primary concern is with gaps and seams in the material just as it is with metal.</p> <p>Current carrying capability of graphite epoxy is adequate for dissipation static charges, but fault currents through graphite epoxy may cause fire at the shorting contact and at joints.</p> <p>The effect of lightning on selected graphite epoxy material and mating surfaces is described, and protection methods are reviewed.</p>				
14. SUBJECT TERMS natural space environment, electromagnetic compatibility, electrical shielding, fault current, electrical and lightning effects on composites			15. NUMBER OF PAGES 69	
			16. PRICE CODE A05	
17. SECURITY CLASSIFICATION OF REPORT Unclassified	18. SECURITY CLASSIFICATION OF THIS PAGE Unclassified	19. SECURITY CLASSIFICATION OF ABSTRACT Unclassified	20. LIMITATION OF ABSTRACT Unlimited	